

# SIL hybrid

## Pump-Action Repeating Bow with Ammo Clips

<https://legolini.com>

**This device is not a toy, it can be very dangerous (can be deadly), so be careful and hide it from children. Do not shoot living beings, use an good quality archery mat/backstop!**

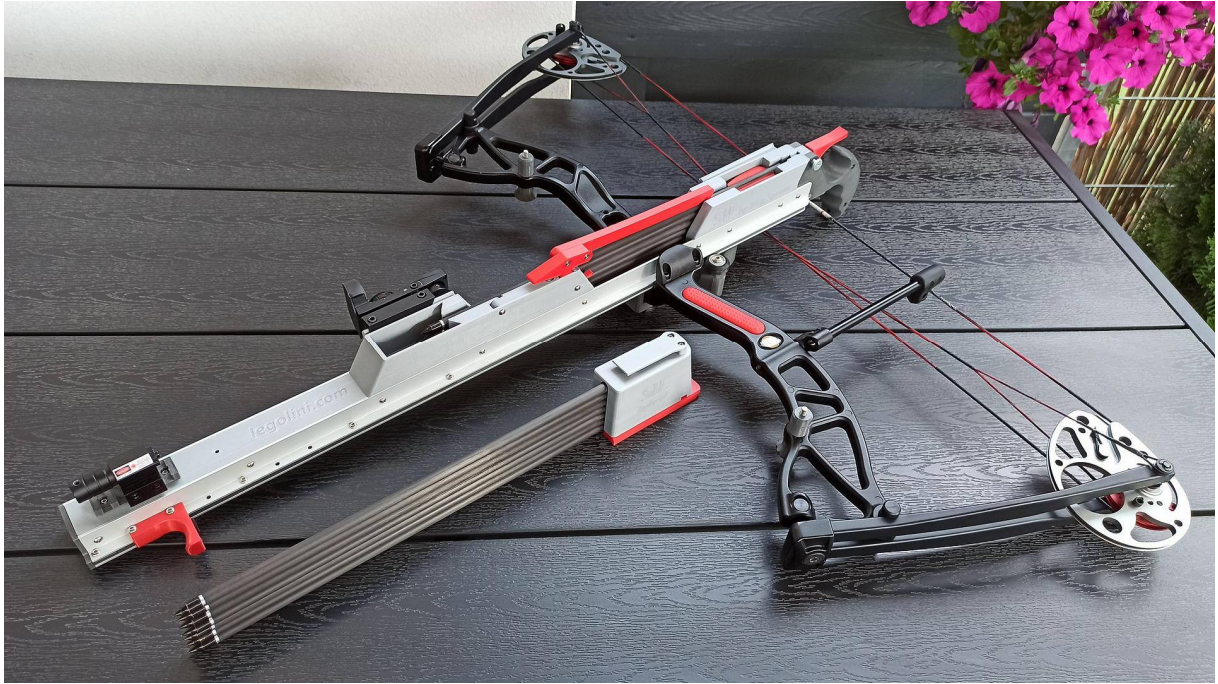

The following information will allow you to build your own SIL repeating bow.

This project is based on the invention of Jörg Sprave from The Slingshot Channel <https://www.youtube.com/user/JoergSprave>, named "Sliding Instant Legolas", commercially available under the name "The Fenris".

I put his name on the back part of the magazine with his permission, to appreciate this great invention.

How it works? Watch this video <https://www.youtube.com/watch?v=a91zx70AqUc>

*If you like this project and appreciate my work, you can support me through PayPal*

[https://www.paypal.com/donate?hosted\\_button\\_id=DTDGEWZF4YA44](https://www.paypal.com/donate?hosted_button_id=DTDGEWZF4YA44)

*You can also support an Inventor who inspires to create interesting things*

<https://www.patreon.com/JoergSprave>

## Table of Contents

Introduction.....	3
3D Printing.....	5
Sanding and smoothing.....	7
Cutting aluminum angles to the correct length .....	9
Drilling holes in aluminum angles.....	15
Magazine parts assembly.....	21
Back grip and release.....	27
Putting the SIL parts together .....	29
Bow adapter .....	30
Red dot sight mount .....	31
Laser sight mount .....	32
Laser sight mount for German users .....	34
Short 4x32 ACOG type scope for long range shooting.....	35
Bow screws for SIL mounting during transport.....	36
Optional ammo clips for fast magazine loading.....	39
Hanging a SIL hybrid bow on the wall (optional).....	41
Bow string serving .....	44
Adjusts the draw length and draw weight of the compound bow.....	47
Compatible bolts, tips and broadheads.....	50
Summary .....	53

## Introduction

**Before you start building, make sure that this type of weapon is legal in your country.**

**I am not responsible for the consequences of building, possession and using this repeating bow.**

**You build it on your own responsibility.**

As "The Fenris" is CNC machined in Austria and very expensive, I decided to make my own cheaper DIY version. I present my vision of Jörg's invention, with some of my proprietary solutions, optimized to be made with 3D printed parts and other easily available materials. SIL hybrid was designed to the EK Archery Assassin / Exterminator compound bow only, but after designing a dedicated adapter, it can also be mounted on other compound bows.

SIL hybrid is pump-action repeating bow with integrated quiver (magazine) for 7 arrows (bolts) and thumb triggered release. Standard 15 inch long bolts (carbon bolts for EK Archery Cobra R9 / Cold Steel Cheap Shot 130 crossbows) can be loaded manually or automatically with additional SIL Ammo Clip, after deflecting the magazine spring lever. Aiming is carried out using a laser sight (up to 15-20 m distance) or red dot sight (up to 30-40 m distance). Possible installation of a short 4x32 ACOG type scope and shooting at longer distances. The magazine is easy to assemble and disassemble on the bow, because the rear handle is tilted away after unscrewing one thumb screw.

The magazine during transport can be also mounted direct to the EK Archery Assassin / Exterminator bow using special screws for the quiver mounting locations.

For German users there is also a dedicated adjustable adapter for the standard round 15x68 mm laser available.

If you don't like the finger draw holder, you can mount a special draw limiter instead (it is also recommended for very fast shooting).

SIL magazine is a hybrid of 4 aluminum profiles (20x10x2 mm angles 700 mm long - from a DIY store) and a dozen or so printed parts on a 3D printer. The aluminum profiles ensure rigidity, while the 3D printed elements merge everything into one with M3 screws. As you can see the construction is quite simple. I used cheap rollers and thumb screws from the 3D printer and some different screws, nuts and springs. The cost of materials is around 40-50 euros. The most difficult is to drill so many holes in the profiles in the right places, but with the prepared templates it can be done relatively easily. The assembly of the whole is not difficult afterwards.

Basic parameters:

- Total length about 795 mm
- Mass weight (bow adapter): about 0,2 kg
- Mass weight (magazine): about 0,9 kg
- Mass weight (magazine with 7 bolts, laser sight and red dot sight): about 1,2 kg

Limitations:

- Magazine is dedicated to the EK Archery Assassin / Exterminator and is compatible with some other bows: [https://legolini.com/sil\\_compatible\\_bows.php](https://legolini.com/sil_compatible_bows.php)
- Draw length is limited in range 20-25 inches (recommended 24 inches)
- Draw weight is limited from 20 lbs (20 inches draw length and -7 turns on bow arms - about 130 fps / 13J) to 50 lbs (25 inches draw length and 0 turns on bow arms - about 245 fps / 47J)

To build SIL hybrid bow you must have:

- EK Archery Assassin / Exterminator compound bow (for SIL it can be without accessories)
- FDM 3D printer with a heatbed of at least 210 x 210 mm
- about 0.6 kg of PLA or PETG filament
- hacksaw, precision files, 180-240 sandpaper
- table drill (recommended) or hand drill
- wrenches, screwdrivers, sharp knife
- CA glue, serving tool, serving thread, string wax, silicone/PTFE grease
- cheap laser sight or red dot sight (without this it's hard to shoot accurately)

#### SIL hybrid:

- 4 aluminum anodized profiles - 20x10x2 mm angles 700 mm long
- 1 piece of M3x10 mm countersunk screw
- 9 pieces M3x10 mm screws with flat round head (+2 pcs for *german\_laser\_mount*)
- 13 pieces M3x12 mm (round)
- 9 pieces M3x16 mm (round)
- 1 piece M3x20 mm (round)
- 2 pieces M3x25 mm (countersunk)
- 2 pieces M3x25 mm (round)
- 1 piece M3x30 mm (hex)
- 5 pieces M3x35 mm (round)
- 36 pieces M3 nut (+2 pcs for *german\_laser\_mount*)
- 2 pieces M3 small thumb nut from 3D printer heatbed
- 2 pieces M5 nut
- 1 piece of steel spring with a outer diameter 8 mm, length 20 mm and wire diameter 0.8-1.0 mm (for *release* trigger part)
- 1 piece of steel spring with a outer diameter 8 mm, length 20 mm and wire diameter 1.0-1.2 mm (*magazine\_spring\_lever*) - 3D printer extruder spring 7.5x20x1.2 mm is also OK
- 1 small steel spring (from a clicky pen) with a outer diameter 4.2 mm, length 20-25 mm (half of the spring for *magazine\_pivot\_lock* and half for *magazine\_part1*)
- if you are printing *german\_laser\_mount*, you also need half a small spring as above.
- 1 steel ball with a diameter of 5 mm

#### Bow adapter:

- 3 pieces OpenBuilds Dual V Wheel
- 3 pieces OpenBuilds 5 mm Bore Eccentric Spacers for V Wheel
- 3 pieces M5x50 mm screws (round head)
- 3 pieces M5 nut
- 3 pieces M5 washer (outer diameter about 15 mm)
- 2 pieces M8 washer (outer diameter about 16 mm)
- 2 pieces 5/16" UNF 1" length screw (for EK Archery Assassin / Exterminator threaded holes)

#### Bow thumb screws:

- 2 pieces M5 nut
- 2 pieces M5x50 mm (hex)

## 3D Printing

You can download STL files for a small fee at:

<https://cults3d.com/en/3d-model/various/sil-hybrid-pump-action-repeating-bow>

The design is optimized for 3D printing with a layer height of 0.2 mm. For reasons of strength and durability, I recommend printing all elements with a wall thickness of 1.6 mm (4 shells), a thickness of 1.2 mm bottom and top walls, and infill 25%. I recommend printing the *magazine\_spring\_lever\_part1* and the *release* with a wall thickness of 2.0 mm (5 shells). I also recommend printing at a slightly higher hotend temperature than usual. I recommend printing on glass bed to make the surfaces smoother. The 3D printer should be well calibrated (extruder steps, flowrate, first layer height). It takes about 40-50 hours to print all parts (depends on the 3D printer).

All parts can be printed without the use of additional supports. Pay attention to the correct direction of bridging when preparing gcode in a slicer program.

Pay special attention to *magazine\_part1* printing. Despite the design of additional surfaces to improve adhesion, on some printers it may be necessary to use a brim, because the areas directly on the bed are very narrow.

Recommended orientation of elements during printing is illustrated by the picture below. All the longer parts on smaller printers must be printed diagonally, rotated 45 degrees.



You can find the current list of compatible bows and available adapters here:

[https://legolini.com/sil\\_compatible\\_bows.php](https://legolini.com/sil_compatible_bows.php)

Choose the correct adapter that fits your bow.

## SIL hybrid bow - STL files map

category	basic	alternative
magazine parts	<i>arrow_guide_part1</i>	
	<i>arrow_guide_part2</i>	
	<i>arrow_guide_part3</i>	
	<i>front_end</i>	
	<i>string_stopper1</i>	
	<i>string_stopper2</i>	
	<i>picatinny_rail_laser</i>	<i>german_laser_mount_part1</i>
		<i>german_laser_mount_part2</i>
	<i>draw_holder</i>	<i>draw_limiter</i>
	<i>magazine_front</i>	
	<i>magazine_part1</i>	
	<i>magazine_part2</i>	<i>magazine_part2_with_scope_rail</i>
magazine spring lever parts	<i>magazine_spring_pivot</i>	
	<i>magazine_pivot_lock</i>	
	<i>magazine_spring_lever_part1</i>	
	<i>magazine_spring_lever_part2</i>	
	<i>magazine_spring_lever_part3</i>	
rear handle parts	<i>back_grip_part1</i>	
	<i>back_grip_part2</i>	
	<i>release</i>	
bow parts	<i>bow_adapter</i>	
	<i>bow_screw_cover</i>	
	<i>bow_screw_distance</i>	
	<i>bow_screw_thumb</i>	
hole templates	<i>ht_bottom_front</i>	
	<i>ht_bottom_middle</i>	
	<i>ht_bottom_rear</i>	
	<i>ht_left</i>	
	<i>ht_left_right_extend</i>	
	<i>ht_right</i>	
	<i>ht_top_front1</i>	
	<i>ht_top_front2</i>	
	<i>ht_top_rear</i>	
wall mount	<i>wall_bracket</i>	
	<i>wall_hook_cover</i>	

STL files with the "ht\_" prefix are specially prepared templates to facilitate drilling holes in aluminum profiles in the right places. Theoretically, it is not necessary to print them, but without them, drilling holes can take much longer.

If you live in Germany, instead of *picatinny\_rail\_laser* you should print special *german\_laser\_mount* for a regular 15x68 mm round laser. All because in this country a laser intended for weapons mounted on a standard 11 or 22 mm rail is illegal. You need also 2 pieces M3x10 mm screws and 2 pieces M3 nuts for this adapter. Half of the spring from the clicky pen is also necessary to adjust the aiming.

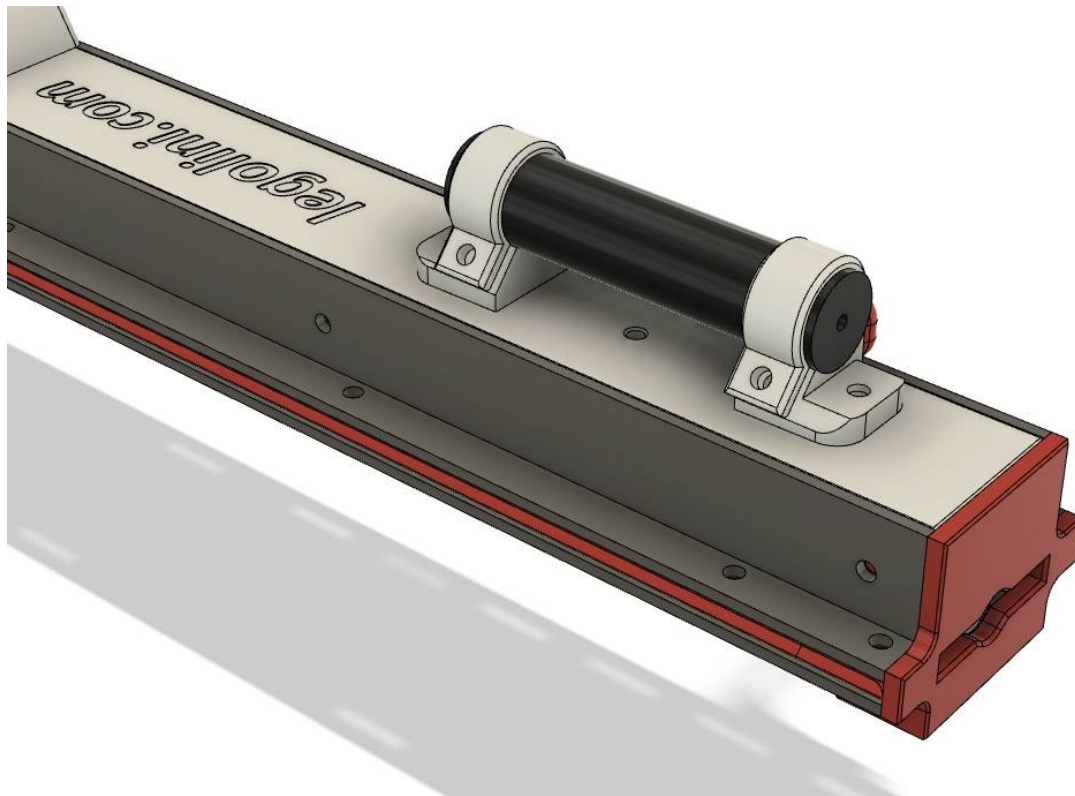

If you don't like the finger *draw\_holder*, you can print a *draw\_limiter* instead (it is also recommended for very fast shooting).

If you want to shoot longer distances, print *magazine\_part2\_with\_scope\_rail* instead of *magazine\_part2*. This part is equipped with an additional picatinny rail, enabling the installation of a short 4x32 ACOG type scope, but remember, this is not a sniper rifle, but a quick-fire weapon.

### **Sanding and smoothing**

After printing, it is absolutely necessary to sand and smooth all print surfaces. All blobs and overflow of filament should be removed. The most important are the upper surfaces of prints, arrow guide ("barrel") and inside magazine.

You need to carefully check all the 3D printed elements and perform sanding and smoothing if necessary. If your printer is well calibrated, you will have little work to do.

To improve bed adhesion when printing, the *magazine\_part1* and *magazine\_part2\_with\_scope\_rail* parts have additional areas designed on the first layer. After printing, cut them with a sharp knife or cutters.

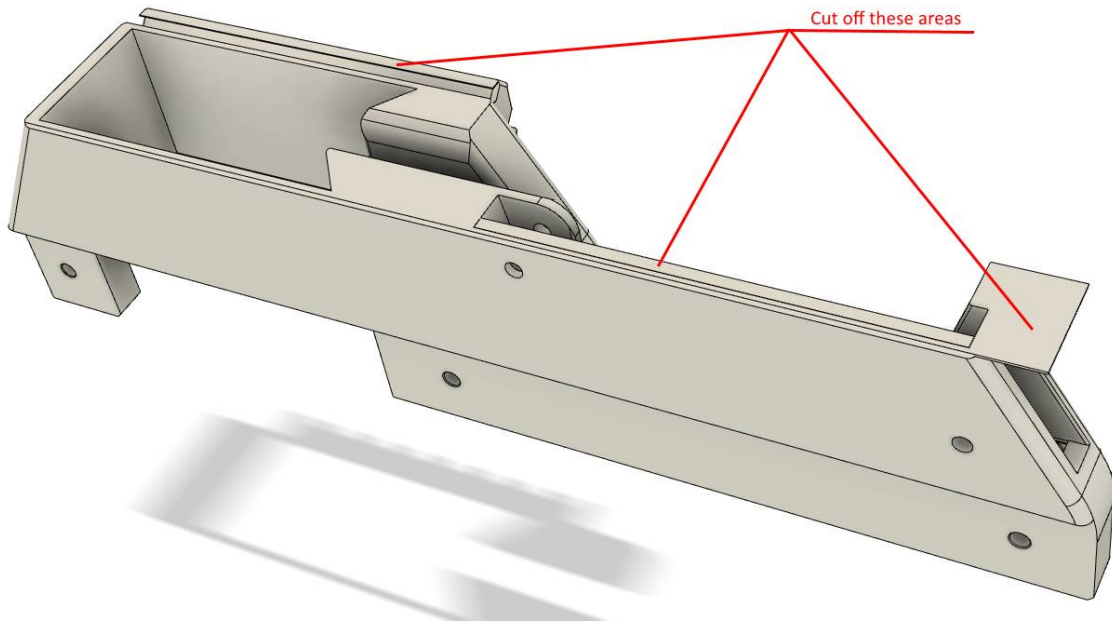

The *magazine\_spring\_pivot* part has one full bridge layer to print that part without supports. A hole should be made in this layer.

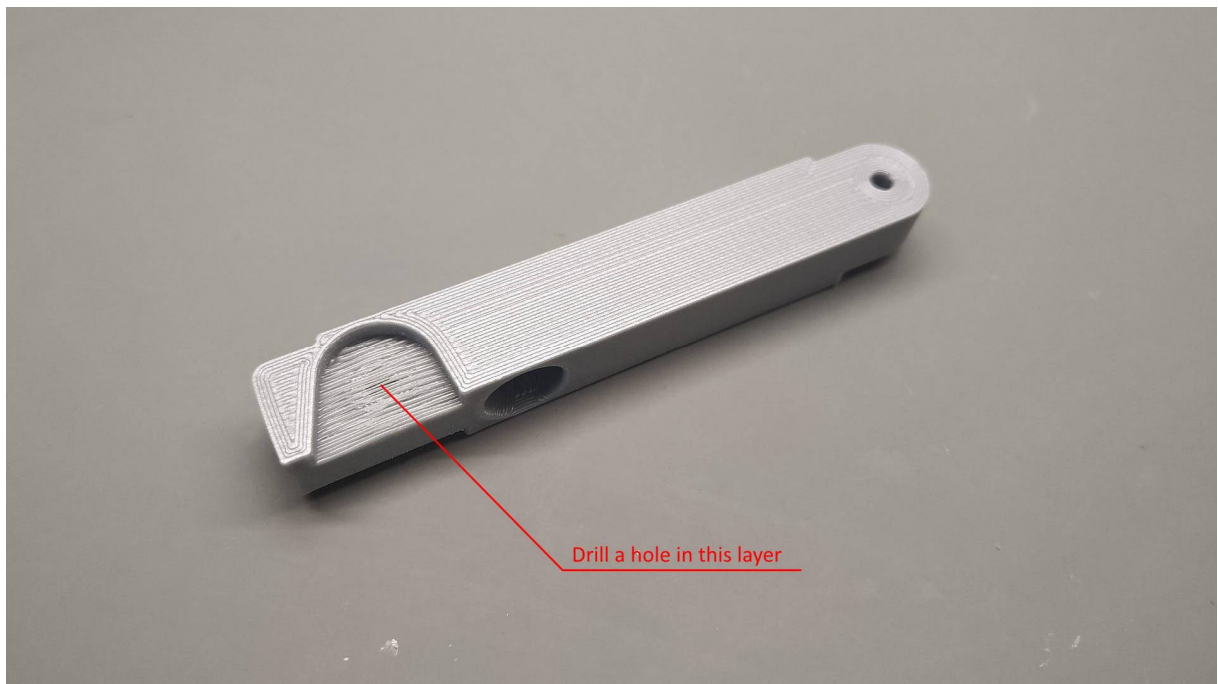



### Cutting aluminum angles to the correct length

We take all 3 parts "arrow\_guide\_" and 2 aluminum profiles. We put the whole thing together and mark the length according to the printed parts. If our 3D printer is well calibrated, the length of the profiles should be about 700 mm.

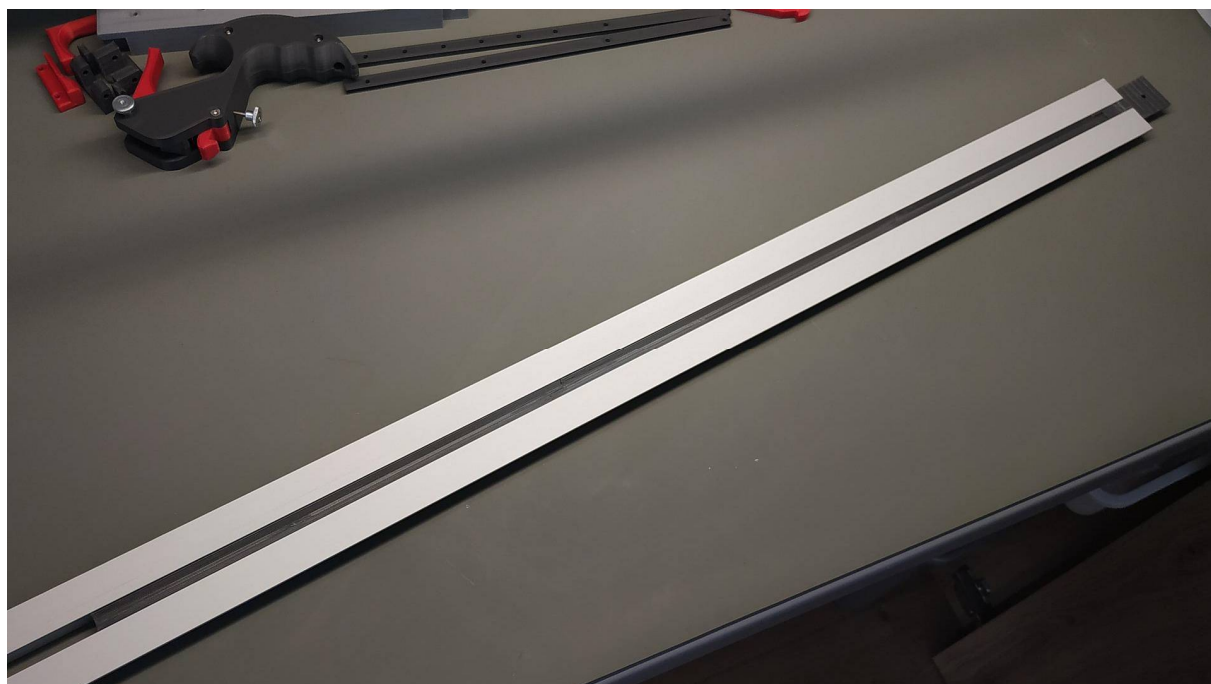

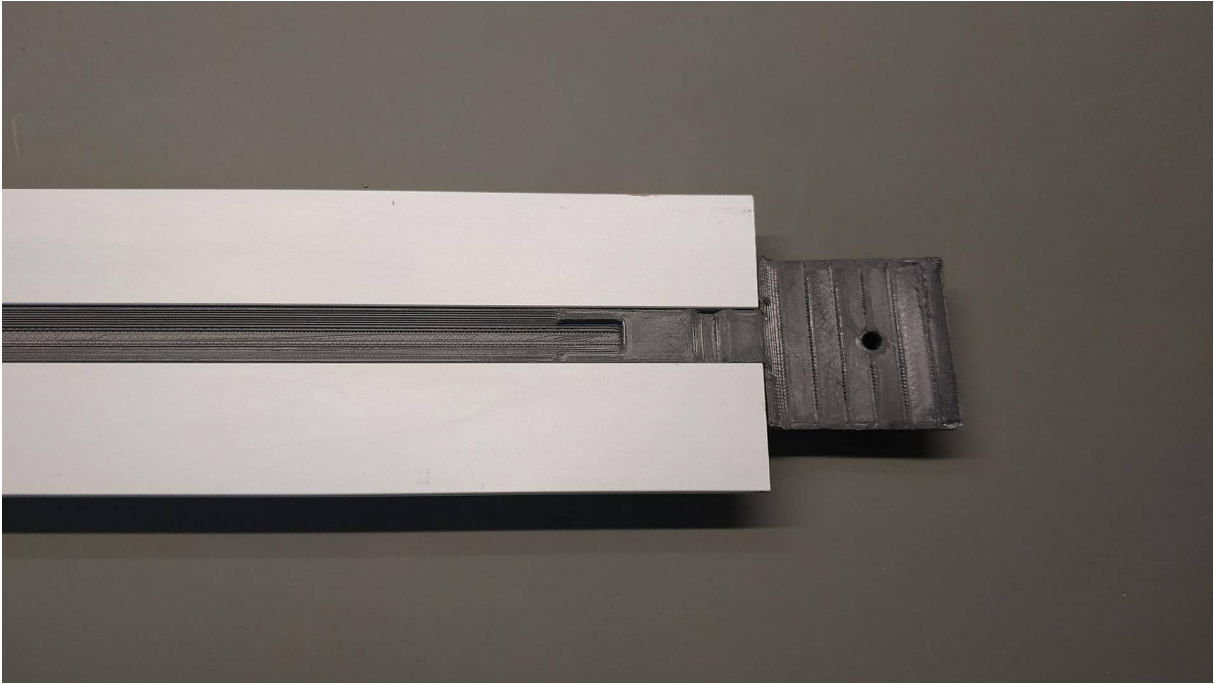

Cut all 4 profiles to the same length in the marked place. I used an electric hacksaw, but may be a handsaw.

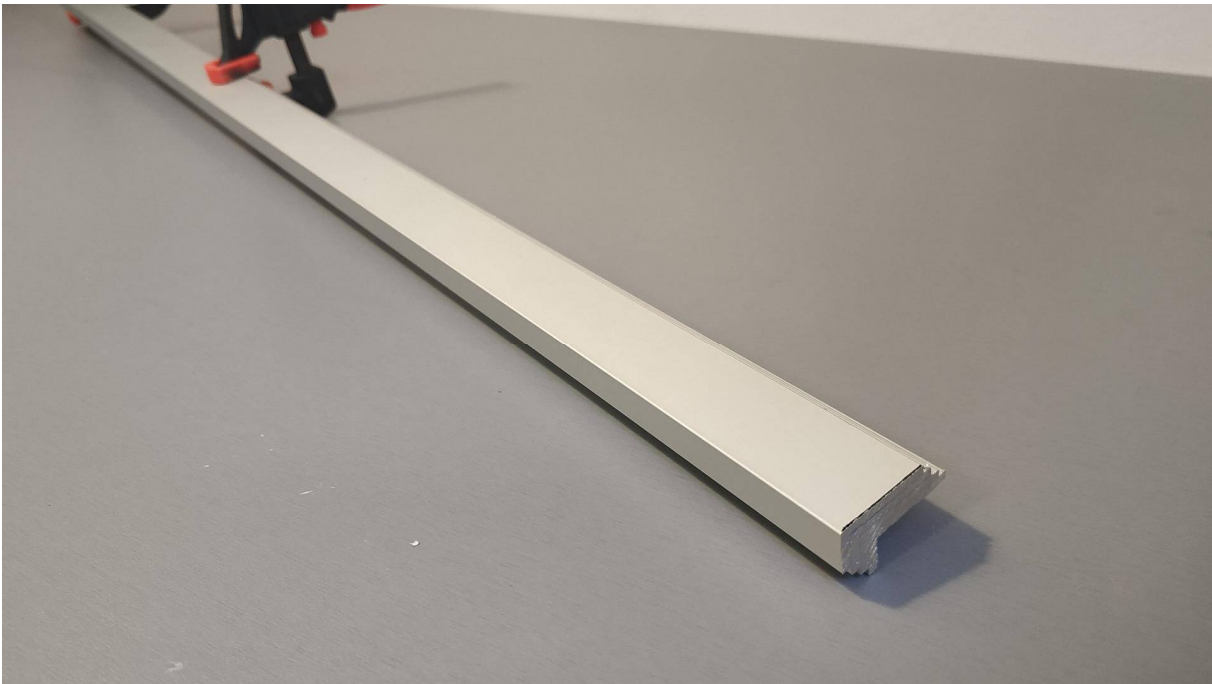
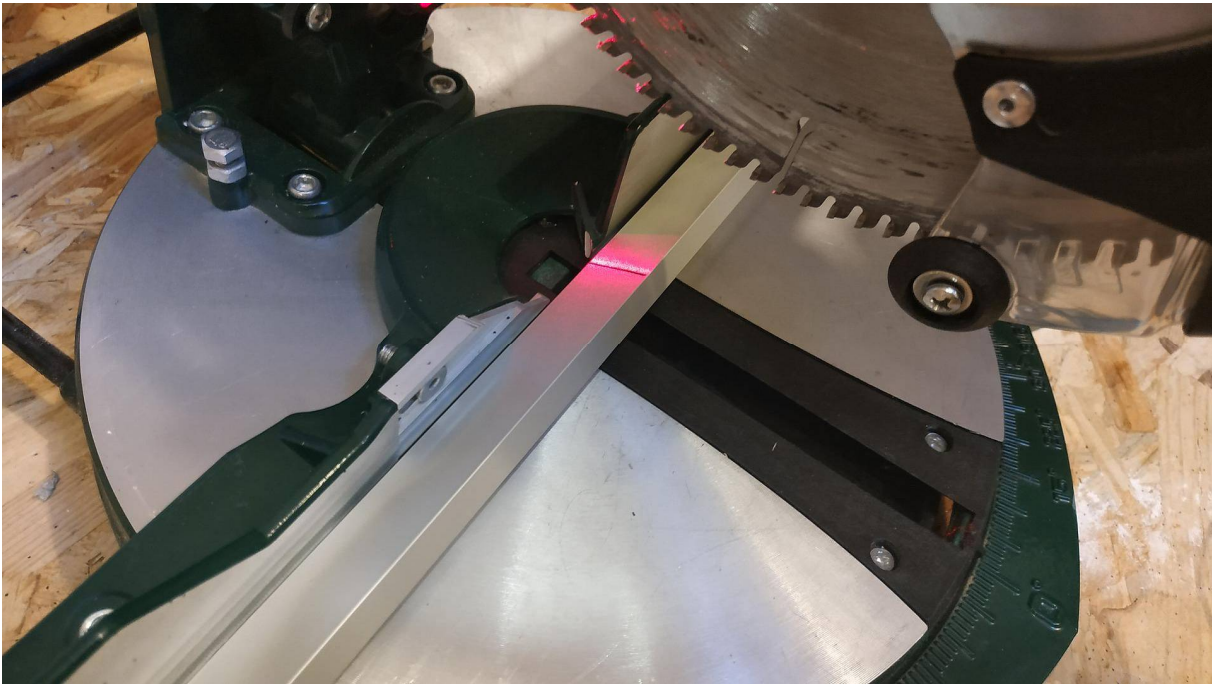

When cut, it should look like this.

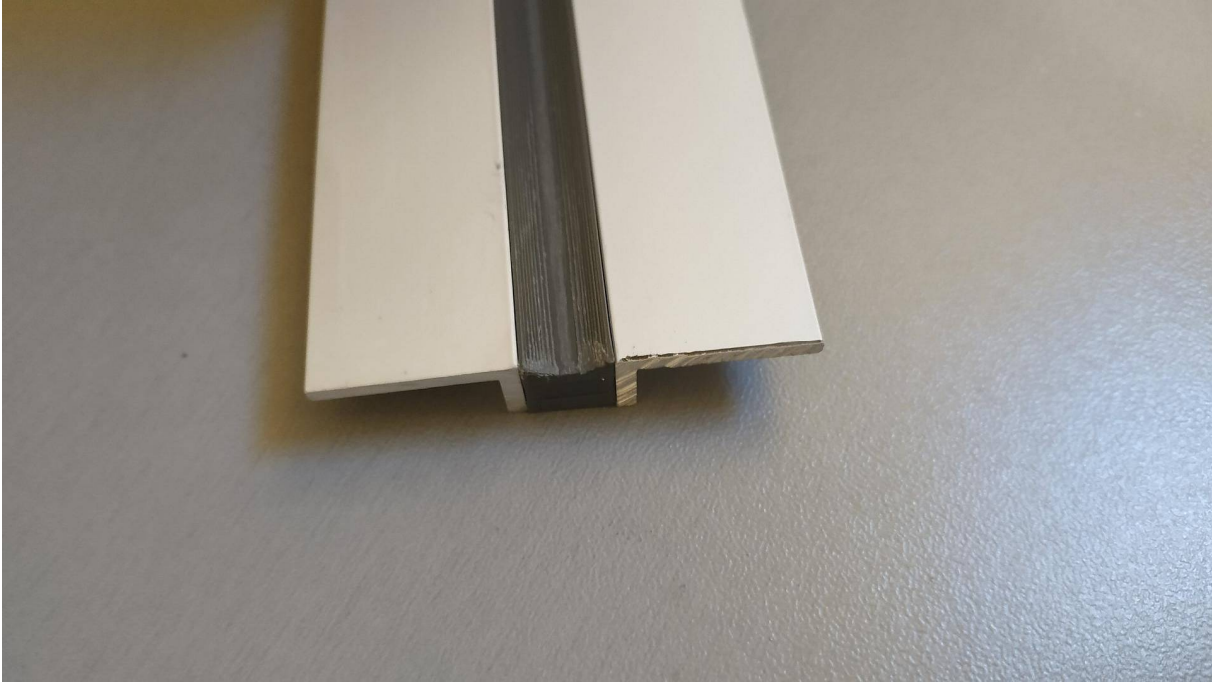

In the next step, mark the parts that need to be cut on the back of the aluminum profiles.

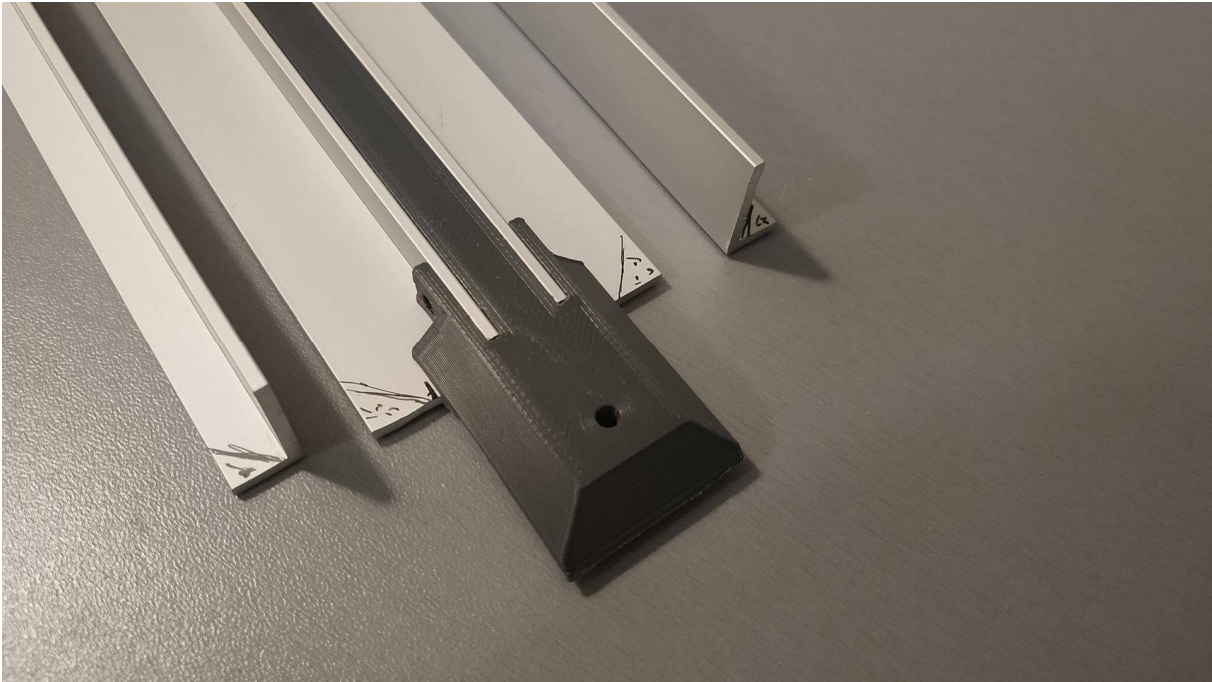



After cutting, we round and smooth the profiles using precision files. All this in order not to damage the bow string during the shot with sharp edges.

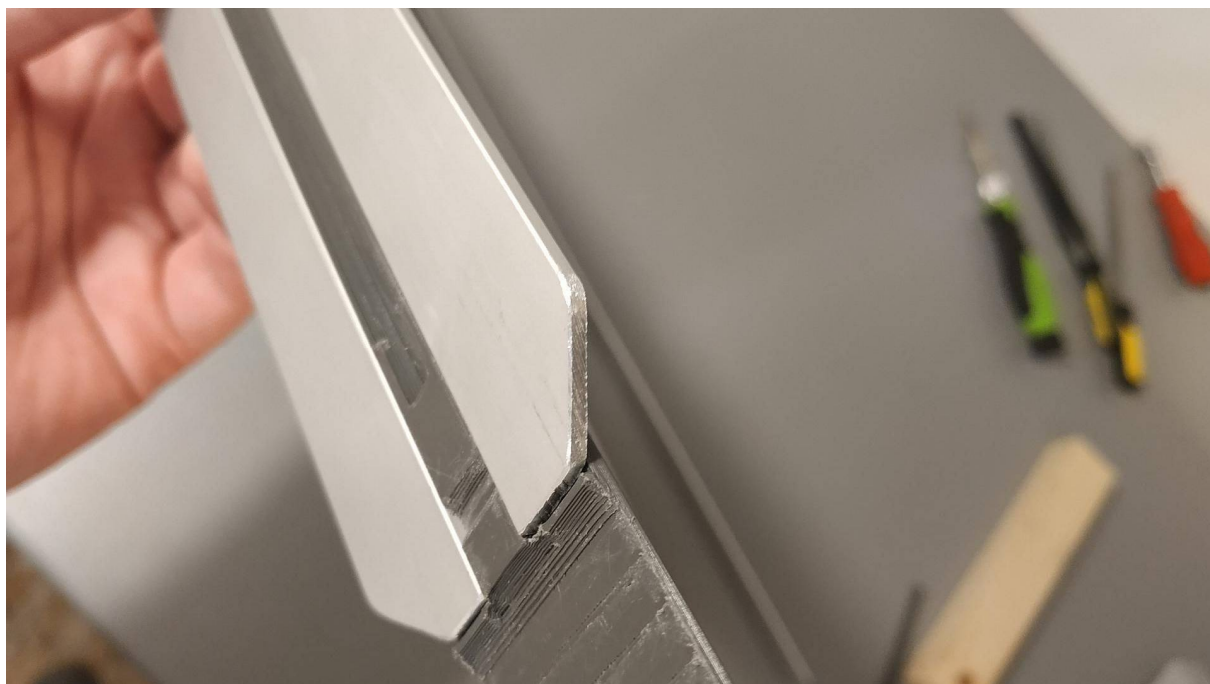

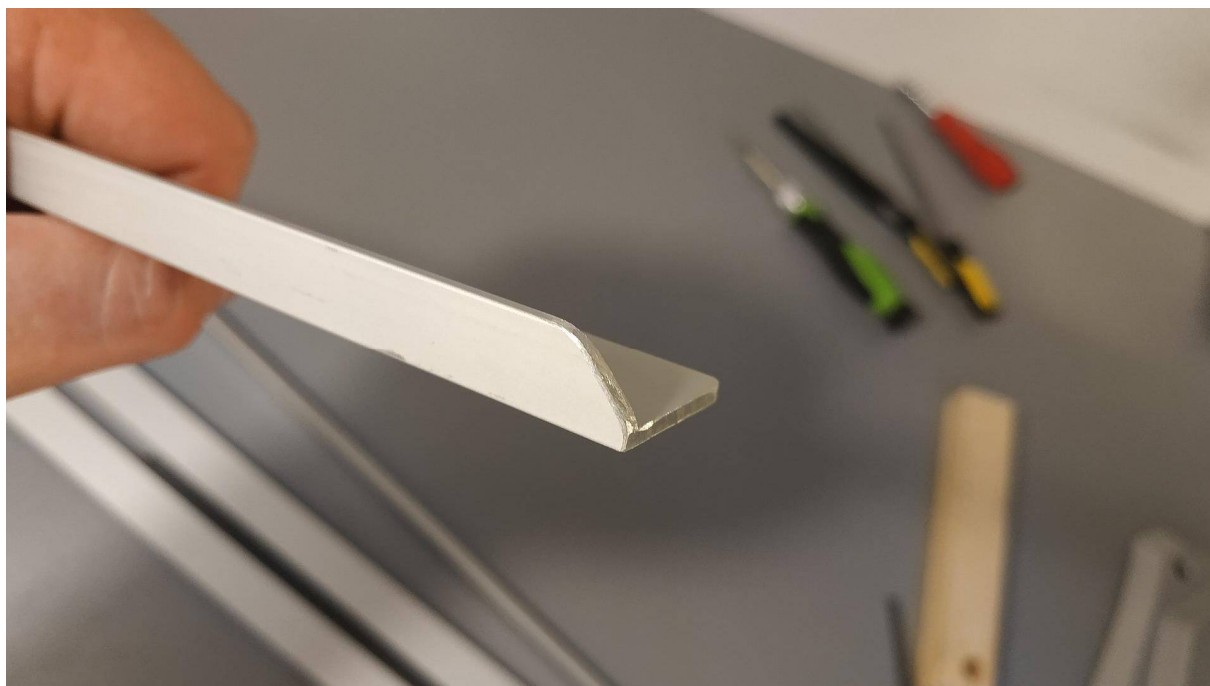

## Drilling holes in aluminum angles

For drilling holes in aluminum profiles, I recommend using a table drill with a 3.0 mm drill bit. This is the hardest part to do, so focus on your work. To determine the drilling locations, use the appropriate 3D printed templates, clamps and M3 screws.

There are 9 templates. Below is an overview drawing with their correct location.

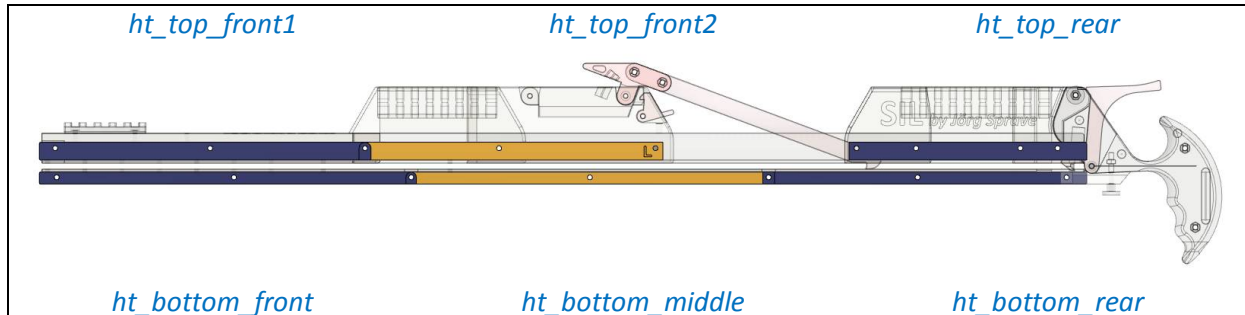

*ht\_top\_front2* - the hole marked with the letter "L" should be drilled only in the left profile.

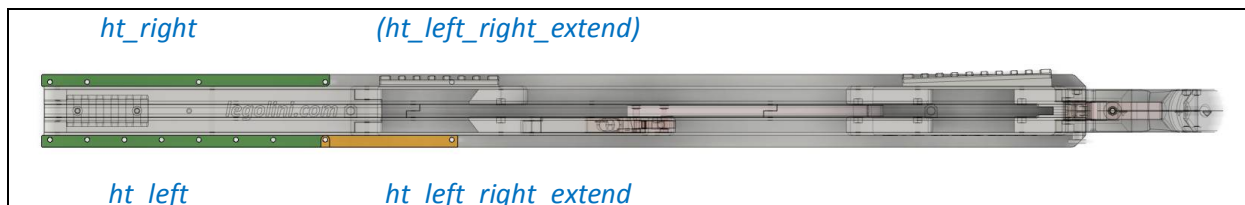

*ht\_left\_right\_extend* - is used on both sides of the SIL to drill the last holes for *string\_stoppers*.

We drill all the holes in turn. We start with *ht\_top\_rear*.



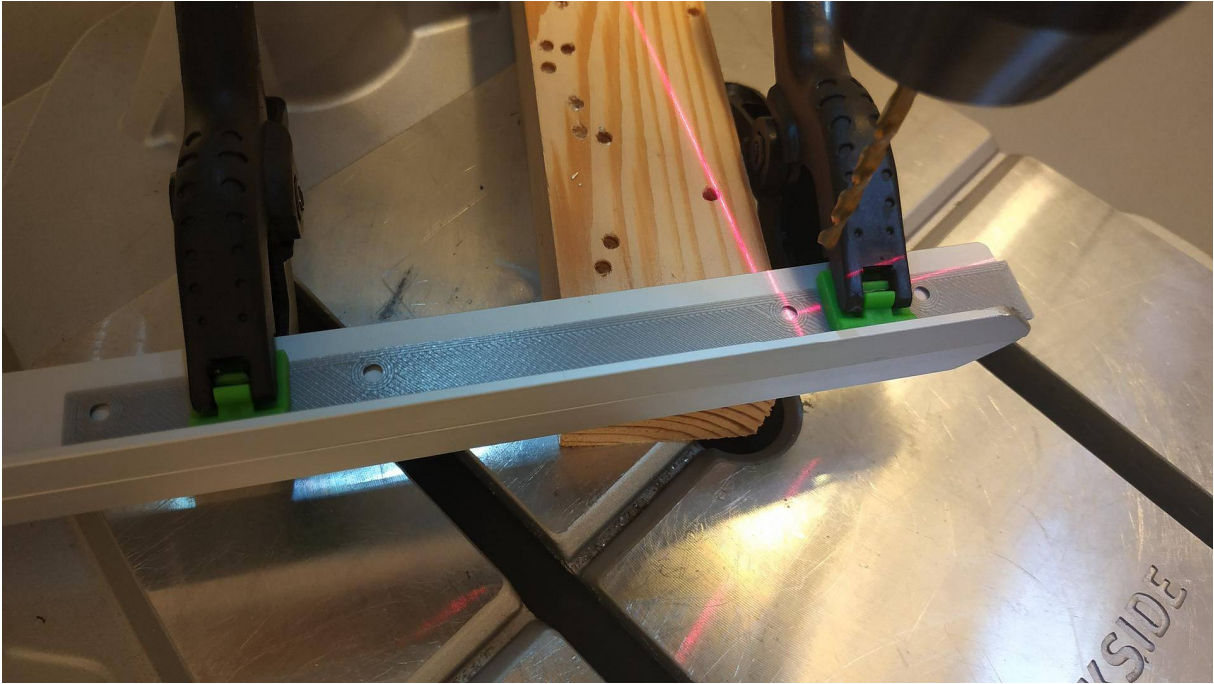

Then *ht\_top\_front1* and *ht\_top\_front2*. We help ourselves with M3 screws and clamps to stabilize the position of the template. The hole marked with the letter "L" should be drilled only in the left profile.







Further parts of *ht\_bottom\_rear*, *ht\_bottom\_middle* and *ht\_bottom\_front*.





Than *ht\_left* and *ht\_left\_right\_extend*.



And *ht\_right* with (*ht\_left\_right\_extend*).

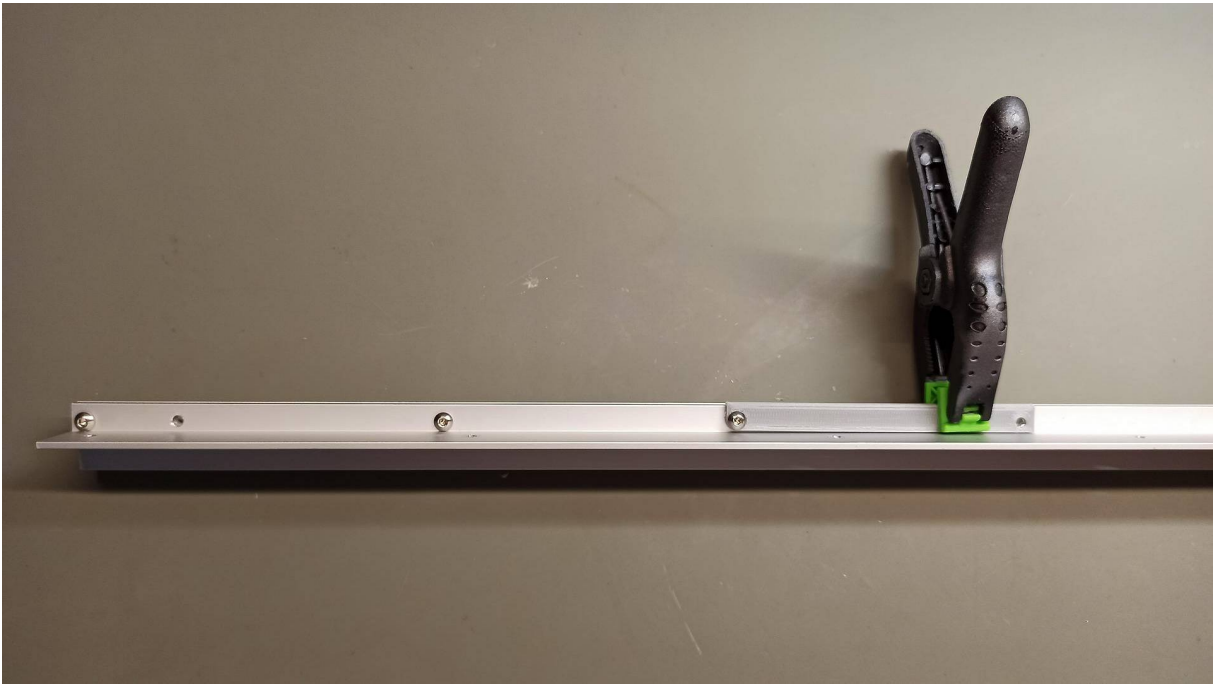

## Magazine parts assembly

If all 3D parts are already smooth and holes in aluminum profiles are drilled, you can proceed to assemble. If the screws fit too tightly in the holes, use a small round file and adjust them.

A special video is prepared that can explain how to assemble the entire SIL device. In this manual there are only photos and a list of elements necessary for assembly. Watch the video to see the rest: <https://www.youtube.com/watch?v=AEsVeXgr3a8>

Later in this manual, you will find timestamped links to the relevant parts of this video.

We'll start with the 3 bottom "arrow\_guide\_" elements and *front\_end*.

First step: <https://www.youtube.com/watch?v=AEsVeXgr3a8&t=9>

For "arrow\_guide\_" parts we need: 5x M3x16 mm, 1x M3x20 mm, 6x M3 nuts, 2x M5 nuts.

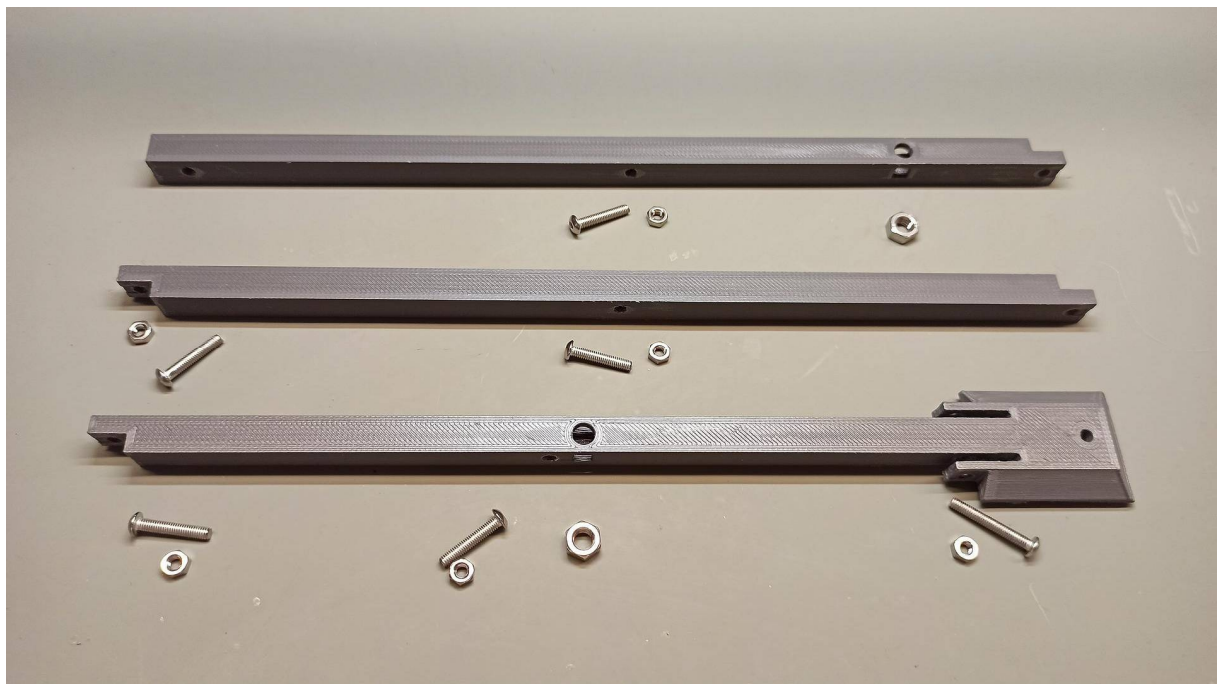

For *front\_end* we need: 2x M3x12 mm, 2x M3x35 mm and 4x M3 nuts. At this stage, we only need one M3x35 mm screw and one M3 nut. You will need the rest of the parts later.

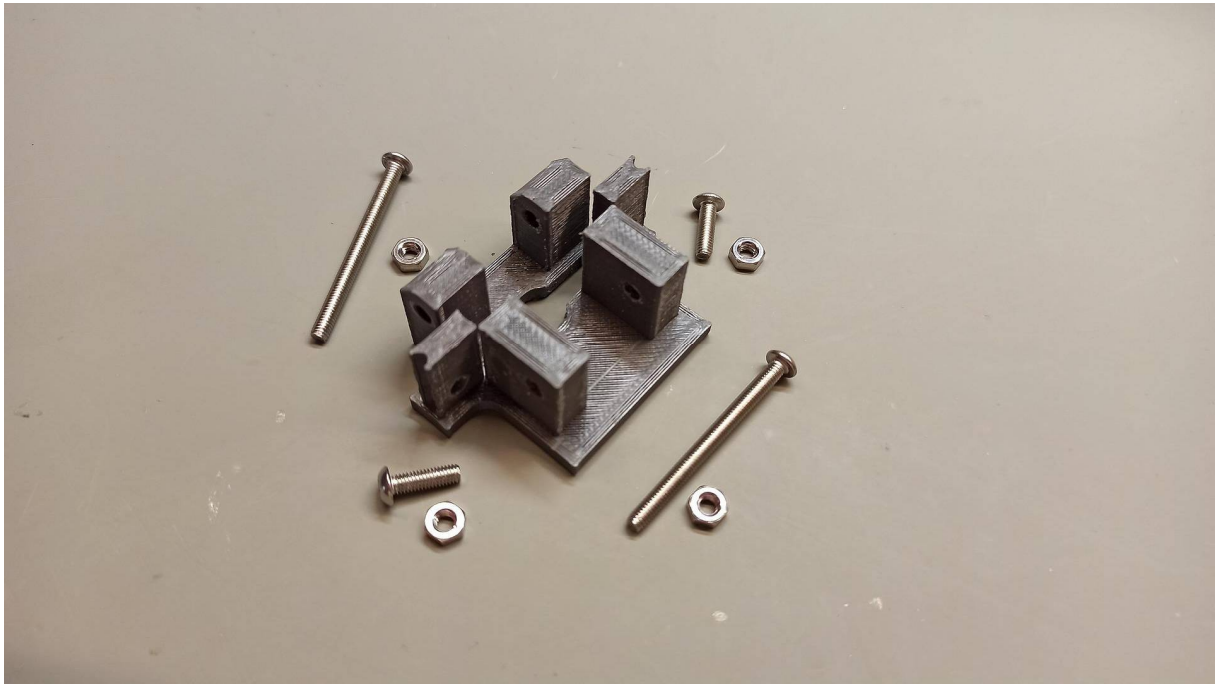

In the second step we mount the rear part of the magazine  
<https://www.youtube.com/watch?v=AESVeXqr3a8&t=242>

For *magazine\_part2* or *magazine\_part2\_with\_scope\_rail* we need: 6x M3x12 mm, 1x M3x35 mm and 7x M3 nuts.

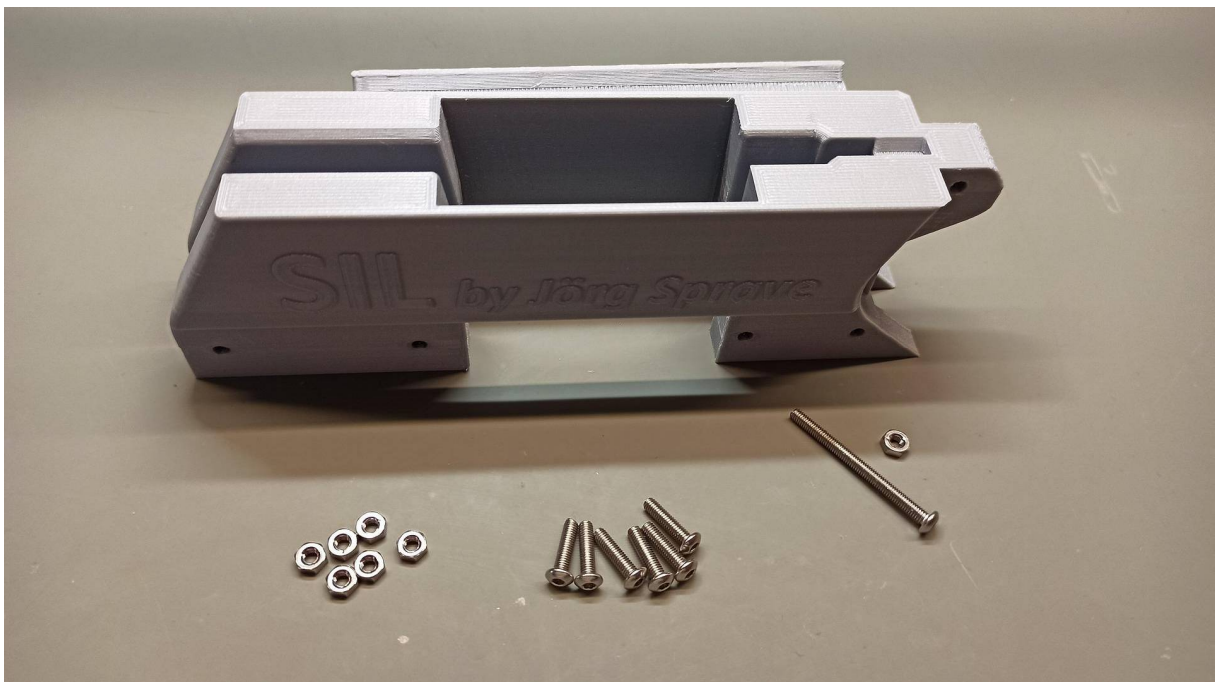

And now front parts of the magazine <https://www.youtube.com/watch?v=AESVeXgr3a8&t=532>

For *magazine\_part1* we need: 3x M3x12 mm and 3x M3 nuts.

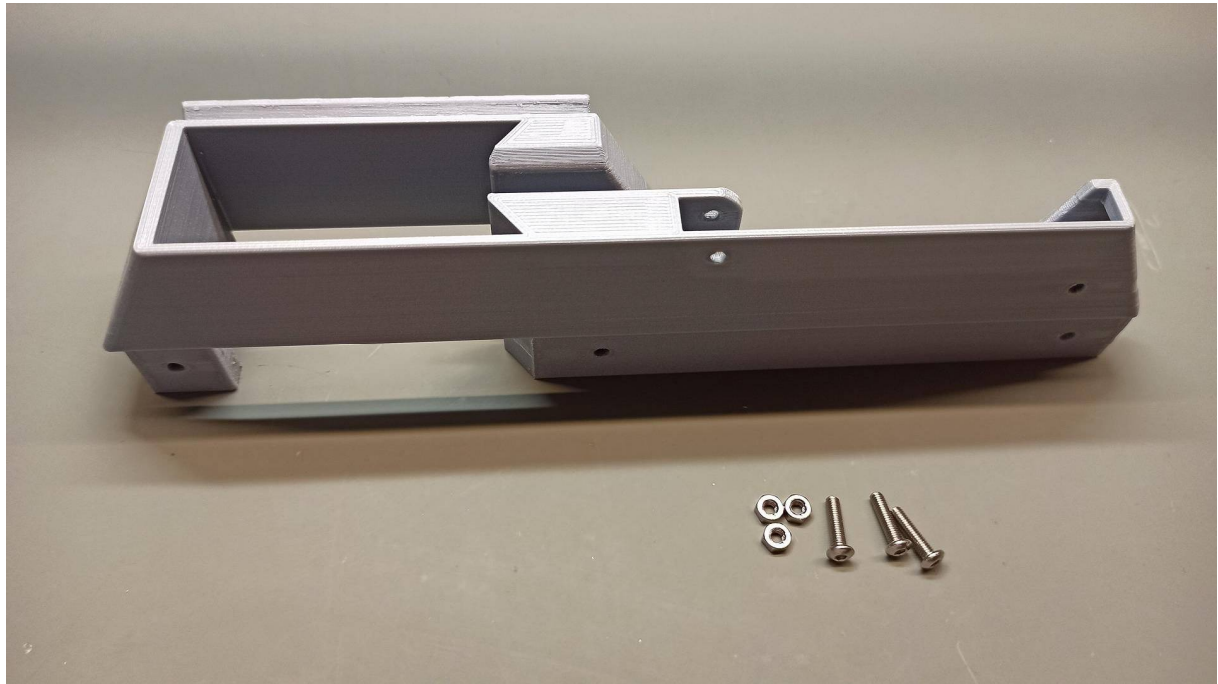

For *magazine\_front* we need: 2x M3x35 mm and 2x M3 nuts.



Now magazine spring lever parts.

First, we glue together *magazine\_spring\_lever\_part2* and *magazine\_spring\_lever\_part3*.

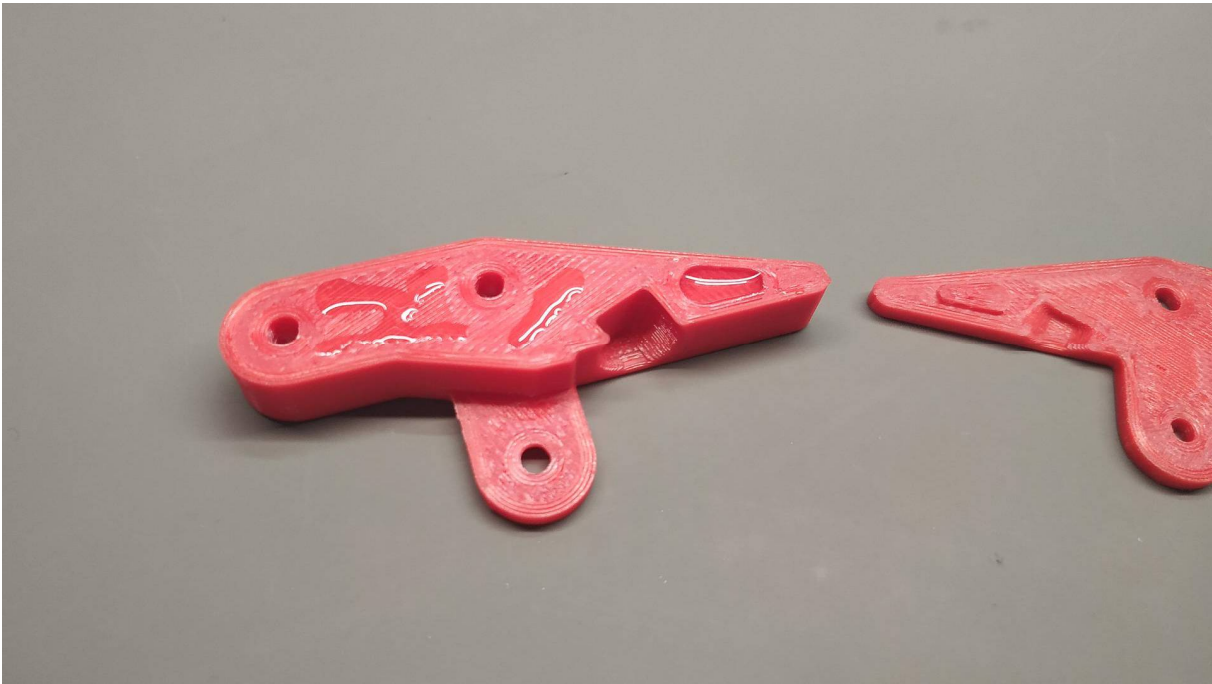



In the next step we mount the magazine spring lever parts

<https://www.youtube.com/watch?v=AESVeXqr3a8&t=679>

For these parts you need: 1x M3x10 mm countersunk, 1x M3x12 mm, 2x M3x16 mm, 2x M3 nuts and 1 piece of steel spring with a outer diameter 8 mm, length 20 mm and wire diameter 1.0-1.2 mm (extruder spring 7.5x20x1.2 mm also work fine).

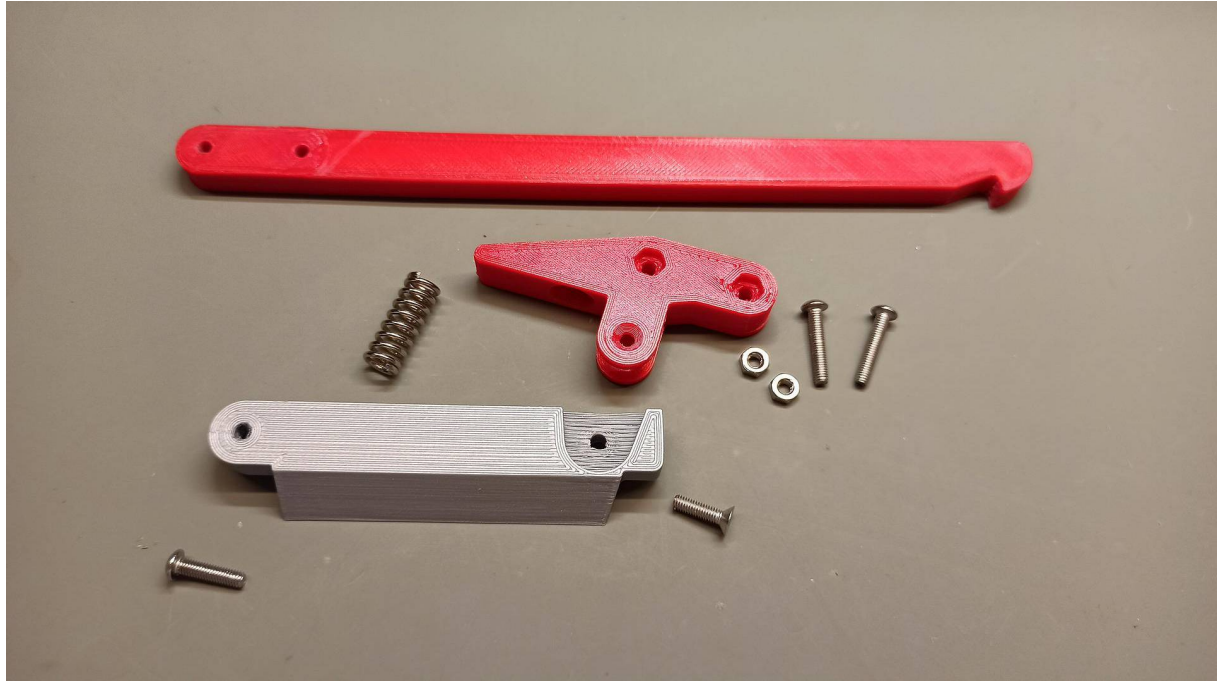

For *magazine\_pivot\_lock* and *magazine\_part1* you need also 1x M3x12 mm, 1 steel ball with a diameter of 5 mm and two halves of a clicky pen spring.

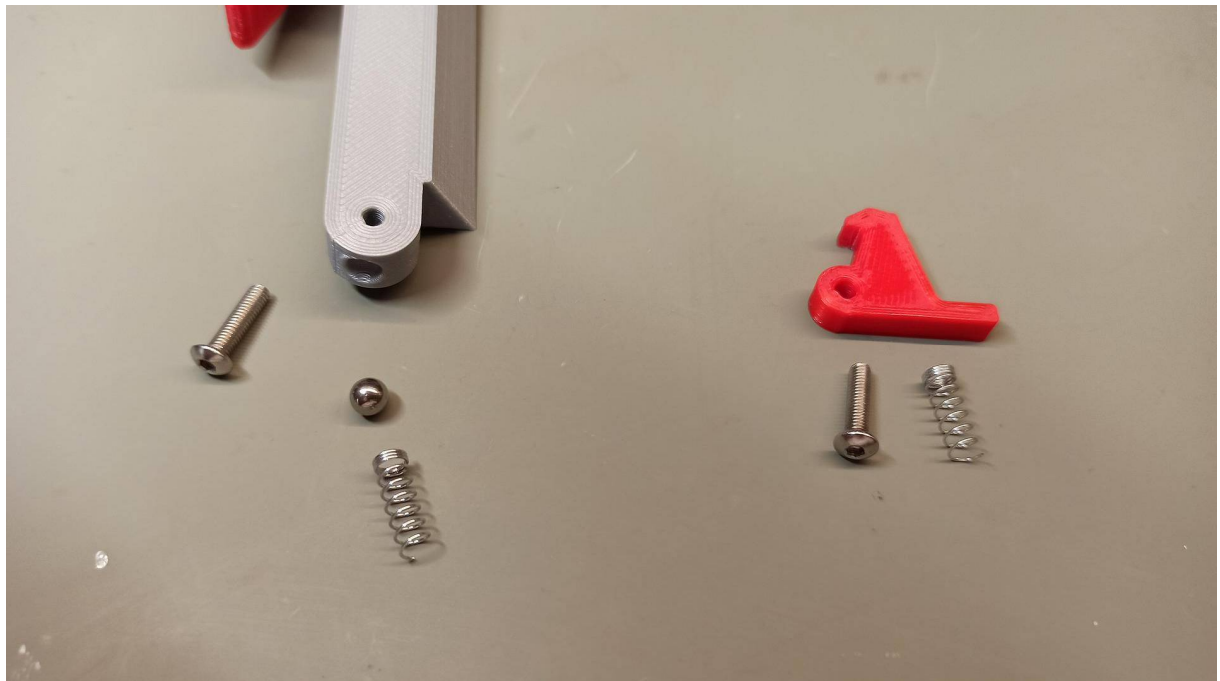

Note that there is no steel ball with half spring in the video. It was added to the project after field testing. SIL will work without them, but if you use them, the *magazine\_spring\_lever* will be kept in the highest open position while loading the magazine, preventing accidental closing (especially important when reloading the magazine quickly with the ammo clip).

Insert the spring into the hole in *magazine\_part1*, then put the ball on the spring. From above, insert the *magazine\_spring\_pivot* gently in a vertical position so that the ball fits into the hollow groove. Then tighten the screw.



## Back grip and release

We start with the preparation of a special thumb screw for quick assembly / disassembly of SIL on a compound bow. For this we need an M3x25 mm screw with a countersunk head and an M3 thumb nut (a small nut for leveling the 3D printer bed).



We make room for the countersunk head using a drill or chamfer.



We twist the two parts together using a little glue (CA or anaerobic thread glue).



We assemble the parts of the rear handle together

<https://www.youtube.com/watch?v=AEsVeXqr3a8&t=854>

For these parts you need: 1x M3x25 mm countersunk with glued M3 thumb nut, 1x M3x25 mm countersunk, 2x M3x25 mm, 1x M3x30 mm hex, 3x M3 nut, 1x M3 thumb nut and 1 piece of steel spring with a outer diameter 8 mm, length 20 mm and wire diameter 0.8-1.0 mm.



### Putting the SIL parts together

The time has come to put together the entire SIL hybrid magazine.

<https://www.youtube.com/watch?v=AEsVeXqr3a8&t=954>

After assembling the top and bottom parts, make sure the arrow moves smoothly in the barrel. If it is too tight, loosen the side screws and increase the distance between the *arrow\_guide* and *magazine\_front*. After adjusting, tighten the screws back.

## Bow adapter

We assemble the bow adapter <https://www.youtube.com/watch?v=AESVeXqr3a8&t=1586>

You can find the current list of compatible bows and available adapters

For this part you need:

- 3 pieces OpenBuilds Dual V Wheel
- 3 pieces OpenBuilds 5mm Bore Eccentric Spacers for V Wheel
- 3 pieces M5x50 mm screws (round head)
- 3 pieces M5 nut
- 3 pieces M5 washer (outer diameter about 15 mm)
- 2 pieces M8 washer (outer diameter about 16 mm)
- 2 pieces 5/16" UNF 1" length screw (for EK Archery Assassin / Exterminator threaded holes)



After assembling the bow adapter, we mount it to the compound bow

<https://www.youtube.com/watch?v=AESVeXqr3a8&t=1741>

And then SIL <https://www.youtube.com/watch?v=AESVeXqr3a8&t=1876>

There are 3 eccentric spacers in the bow adapter. Thanks to them, it is possible to adjust the friction of the rollers and the play on the SIL rail. The adjustment should be made on the lower single spacer and M5 screw. Rollers wear out over time (they are made of plastic with a V-shaped cross-section, while the SIL rail is a rectangular cross-section with a width of 2 mm). If the adjustment range is insufficient, unscrew and turn the 2 upper eccentric spacers by the same angle (60°, 120° or 180°).

## Red dot sight mount

It is recommended to use red dot sight for aiming. In order to mount the red dot sight, use the picatinny rail built into the front part of the magazine.

<https://www.youtube.com/watch?v=AESVeXqr3a8&t=1533>

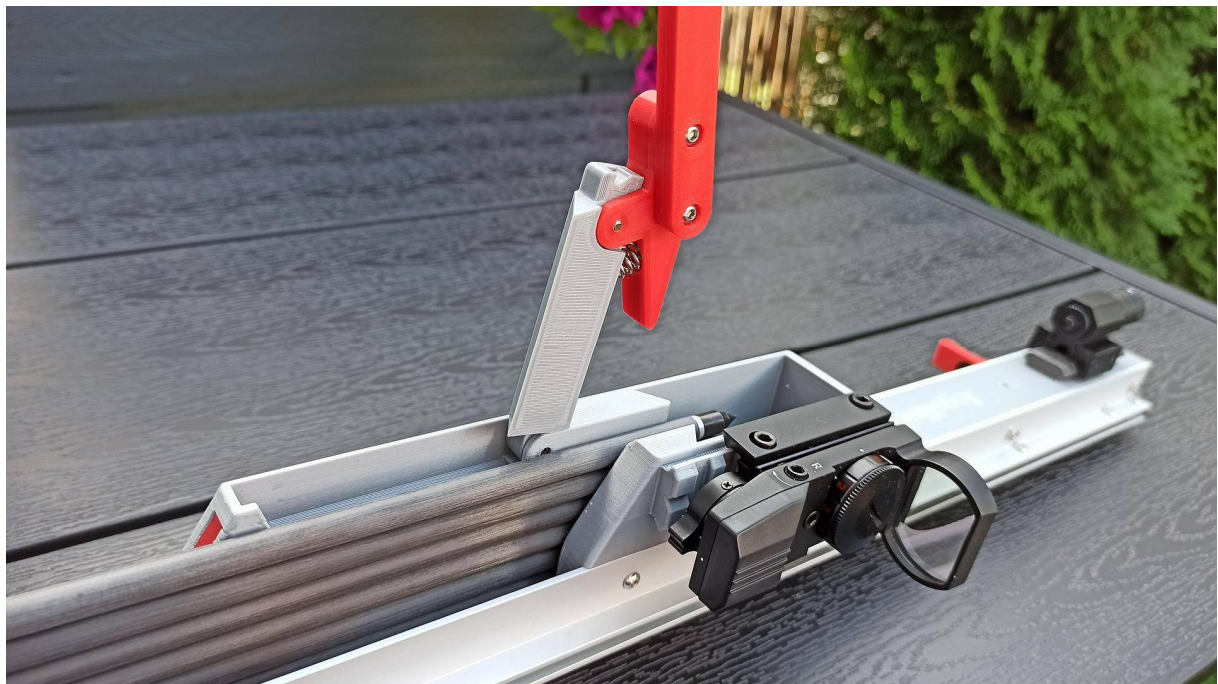

## Laser sight mount

For super fast shooting at short distances, it is very good to use the laser sight. To do this, screw the printed *picatinny\_rail\_laser* to the front of the magazine with two M3 x 12 mm screws, then mount the laser sight on the rail.

<https://www.youtube.com/watch?v=AESVeXqr3a8&t=1449>





It is also possible to mount a flashlight with an integrated laser sight.



### Laser sight mount for German users

If you live in Germany you should print special *german\_laser\_mount* for a regular 15x68 mm round laser. All because in this country a laser intended for weapons mounted on a standard 11 or 22 mm rail is illegal. You need also 2 pieces M3x10 mm screws and 2 pieces M3 nuts for this adapter. Half of the spring from the clicky pen is also necessary to adjust the aiming.

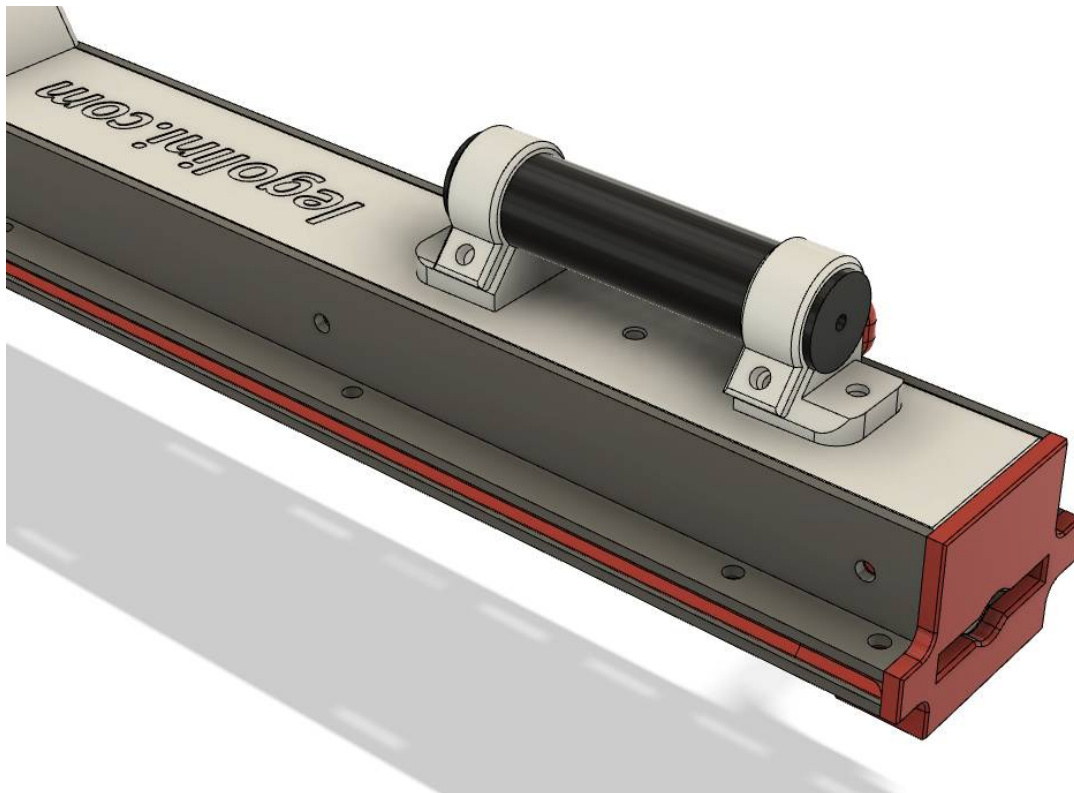

### Short 4x32 ACOG type scope for long range shooting

By printing *magazine\_part2\_with\_scope\_rail*, a short 4x32 optical sight can be mounted on the SIL. Such an optical sight will facilitate shooting at distances above 30 m, but will add additional weight to the device, which makes shooting much more difficult. Remember that this is not a sniper rifle, but a quick-fire weapon.

The sight is mounted on the end of the picatinny rail integrated with the rear part of the magazine.

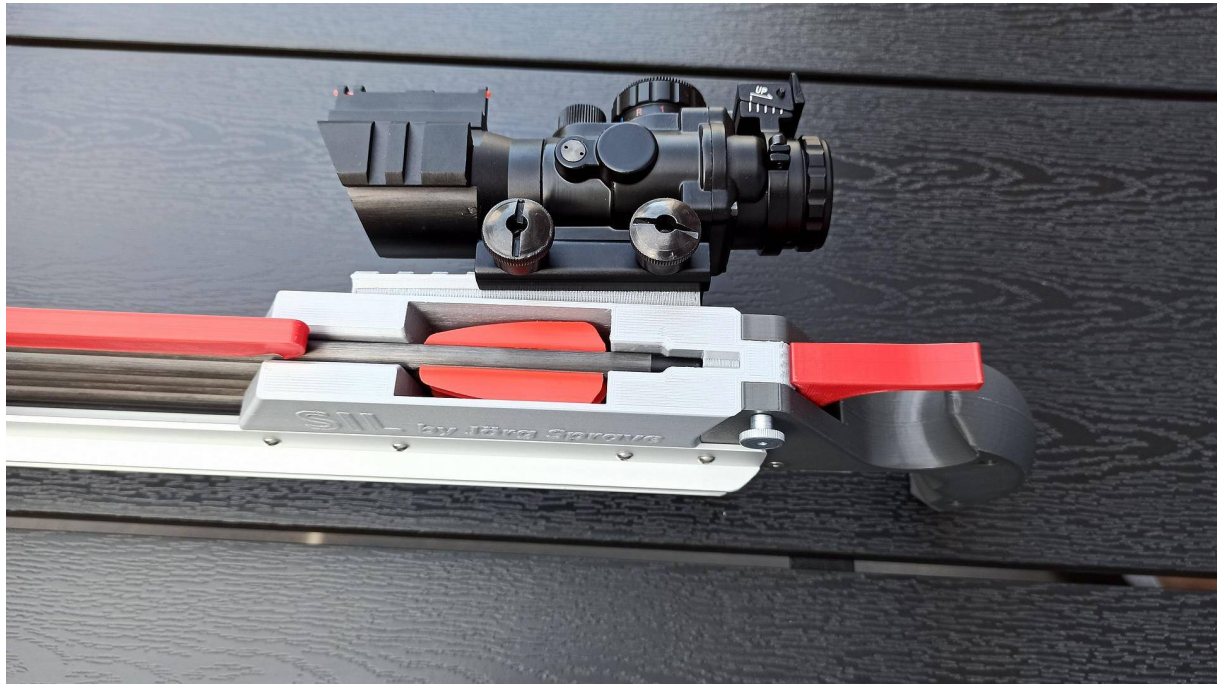

### Bow screws for SIL mounting during transport

The magazine during transport can be also mounted direct to the EK Archery Assassin / Exterminator bow using special screws for the quiver mounting locations.

You need to print 2 sets of "bow\_screw\_" files. You also need two M5x50 mm hexagonal screws and two M5 nuts.





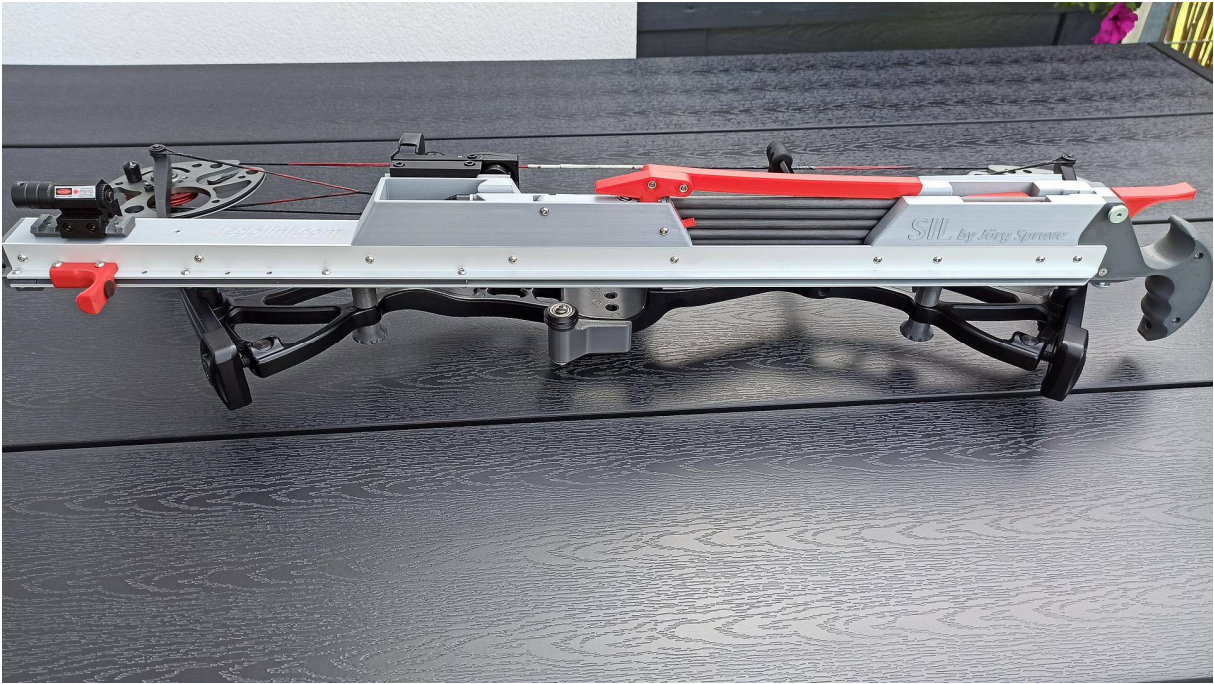

## Optional ammo clips for fast magazine loading

I think this video will explain how it works.

<https://www.youtube.com/watch?v=MIFtDrykbh0>

You can download STL files for a small fee at:

<https://cults3d.com/en/3d-model/various/sil-ammo-clip-speed-loader-for-sil-hybrid-repeating-bow>

SIL Ammo Clip is dedicated for 7 standard bolts, 15 inches long and 7.5 mm in diameter (carbon bolts for EK Archery Cobra R9 / Cold Steel Cheap Shot 130 crossbows). This ammo clip is 3D printed (5 parts) and requires only 6 external elements to work - 5 pieces M3x16 mm screws with round head and small spring from a clicky pen (4.2 mm diameter and about 20-25 mm length).

When loading the magazine, it is recommended to tilt the bow slightly to the left and back and rest the rear bow handle on the hip. The rest is done by gravity when the ammo clip moving backwards. If the bolts accidentally do not fall out of the ammo clip, you can use the magazine spring lever or your hand to load the bolts into the magazine. With a little practice, you can load a magazine very quickly.

For details, see [https://legolini.com/sil\\_ammo\\_clip.php](https://legolini.com/sil_ammo_clip.php)

How to assemble? <https://www.youtube.com/watch?v=AESVeXqr3a8&t=1940>







### Hanging a SIL hybrid bow on the wall (optional)

The SIL rear handle has a hole that allows the set to be hung on the wall using a standard wall mounted straight hook. The weapon may be used immediately after it has been removed from the hook (e.g. in self-defense).

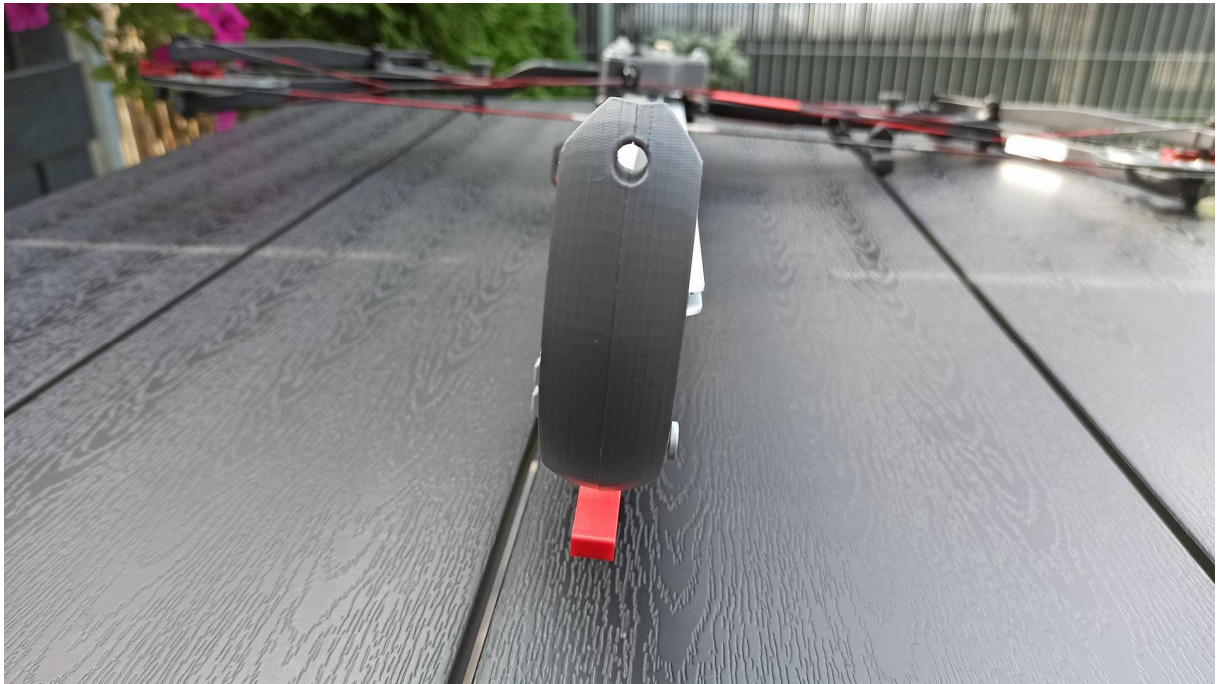

To hang the SIL hybrid bow on the wall, you should print the *wall\_bracket* and *wall\_hook\_cover* parts. You also need a hook, screw and wall plugs. The vertical distance between the holes should be 28 cm.



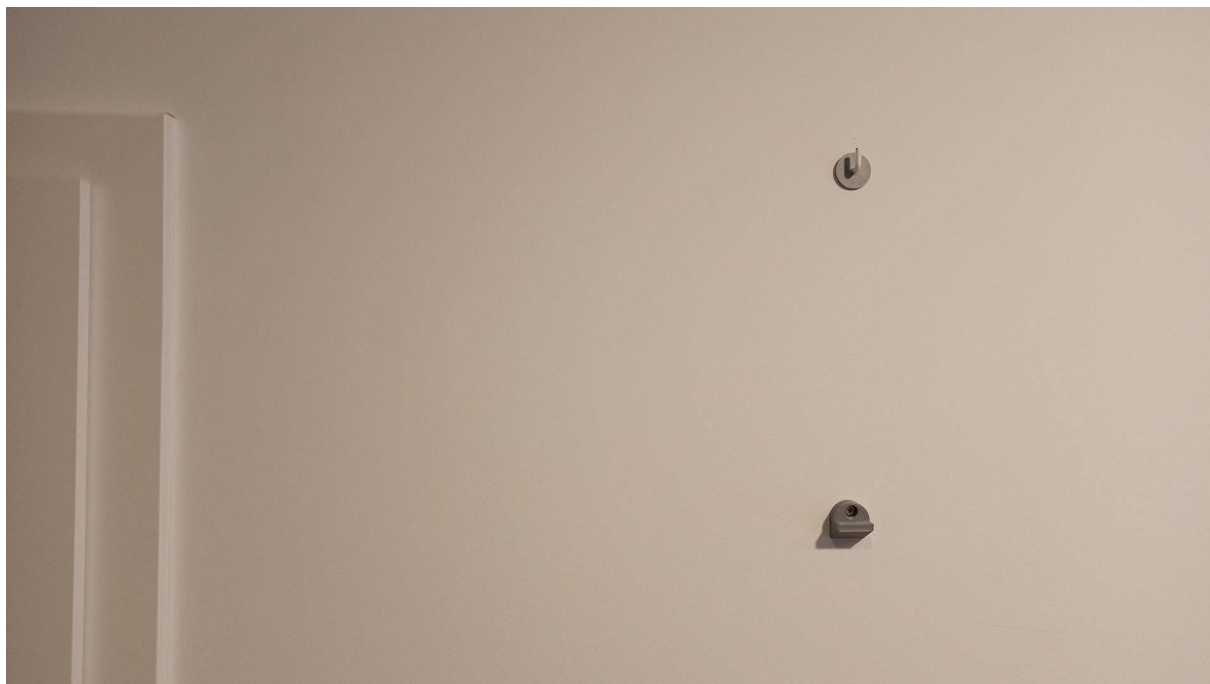
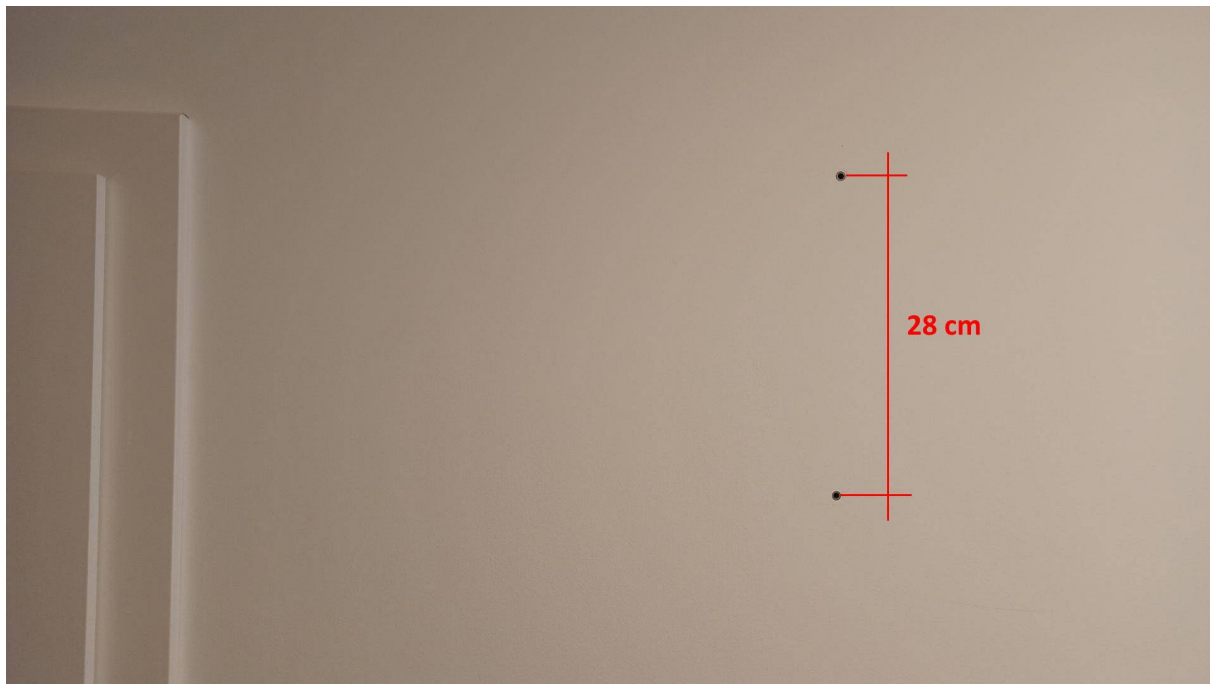



## Bow string serving

To increase the reliability of the device and extend the life of a compound bow string, an additional string serving should be made.

**Warning! Check the condition of the middle serving regularly every 40-50 bow shots. If the damage is minor, just apply and rub in string wax and additionally PTFE grease.**



**If the string serving starts to fray, replace it immediately. Shooting with a damaged string can damage the entire compound bow and cause injury.**

You should make an additional serving on the factory serving, about 60-80 mm long in the place where the string moves in the magazine slot.

By Jörg Sprave: *traditional - and very effective - method is to "serve" the string, means, wrapping it very tightly with a special type of waxed string for crossbows.*

*You can get such string very inexpensively in archery stores, and online for example <https://amzn.to/3ajOjNt>*

*There are plenty of instructional videos how to serve a bow string (for example <https://www.youtube.com/watch?v=0hwQiKAWl2k>), but basically you tie a knot, apply a tiny drop of CA glue and then you start winding. At the end, one more drop and one more knot. You can then rub in a bit of string wax and voilá, you have a string that will last for a loooong time.*

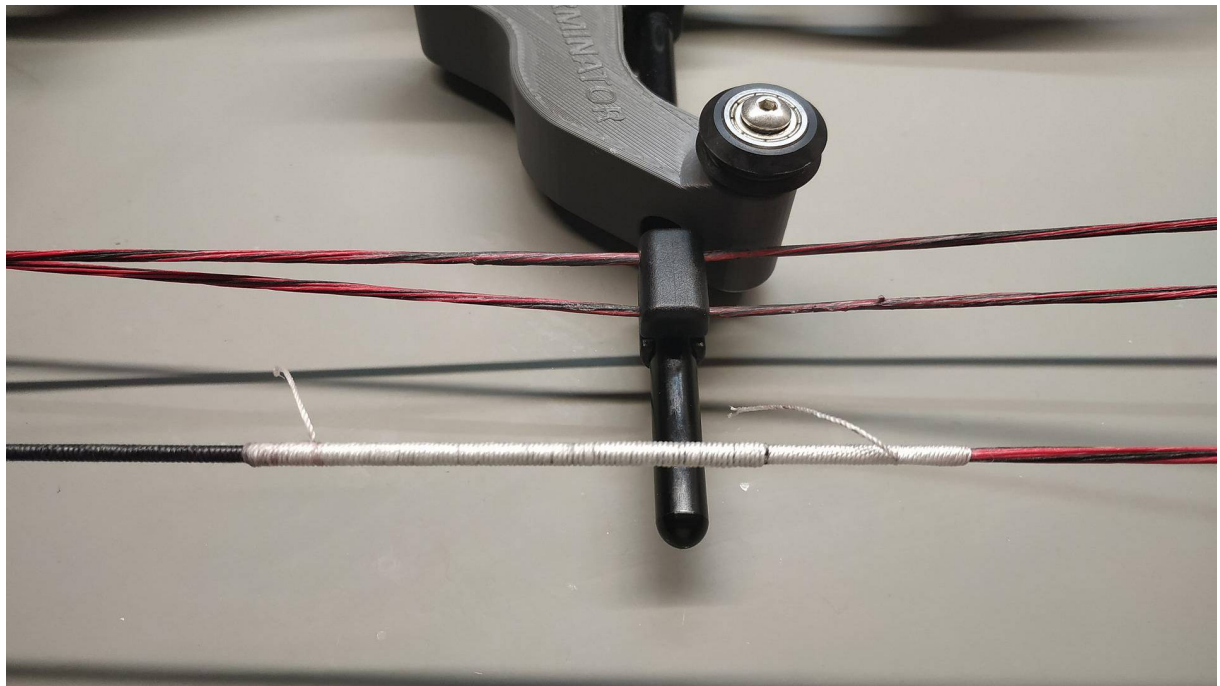
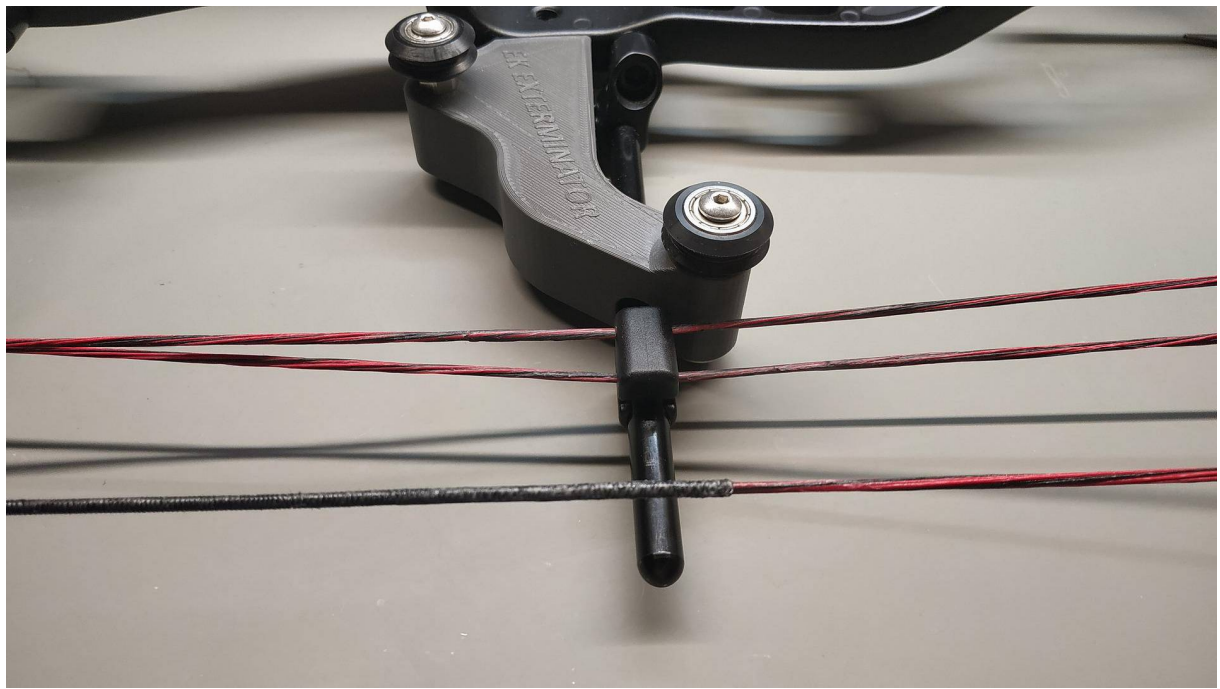

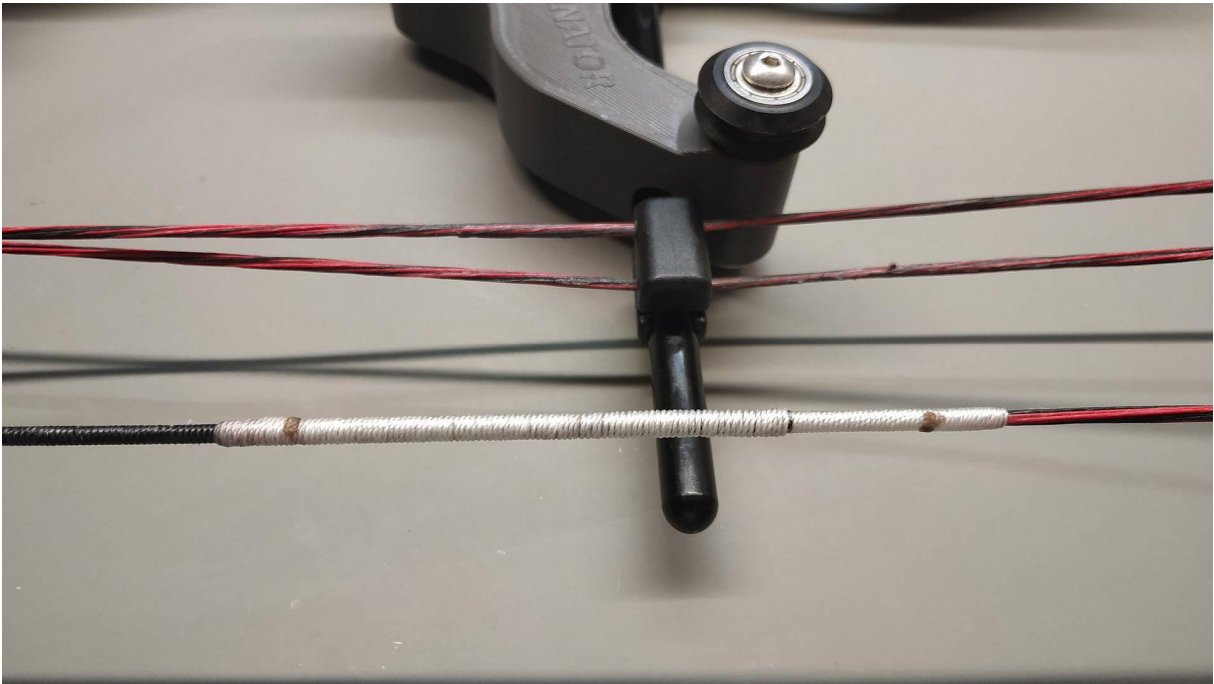
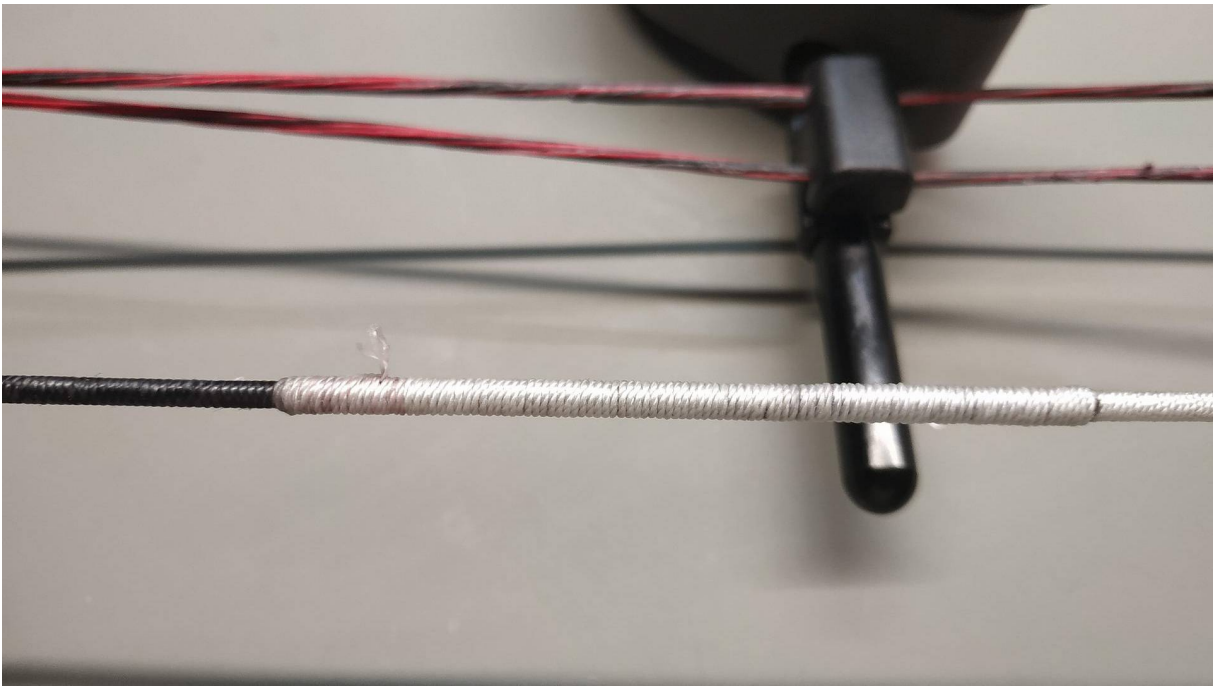

At the end apply and rub in string wax and some PTFE grease.

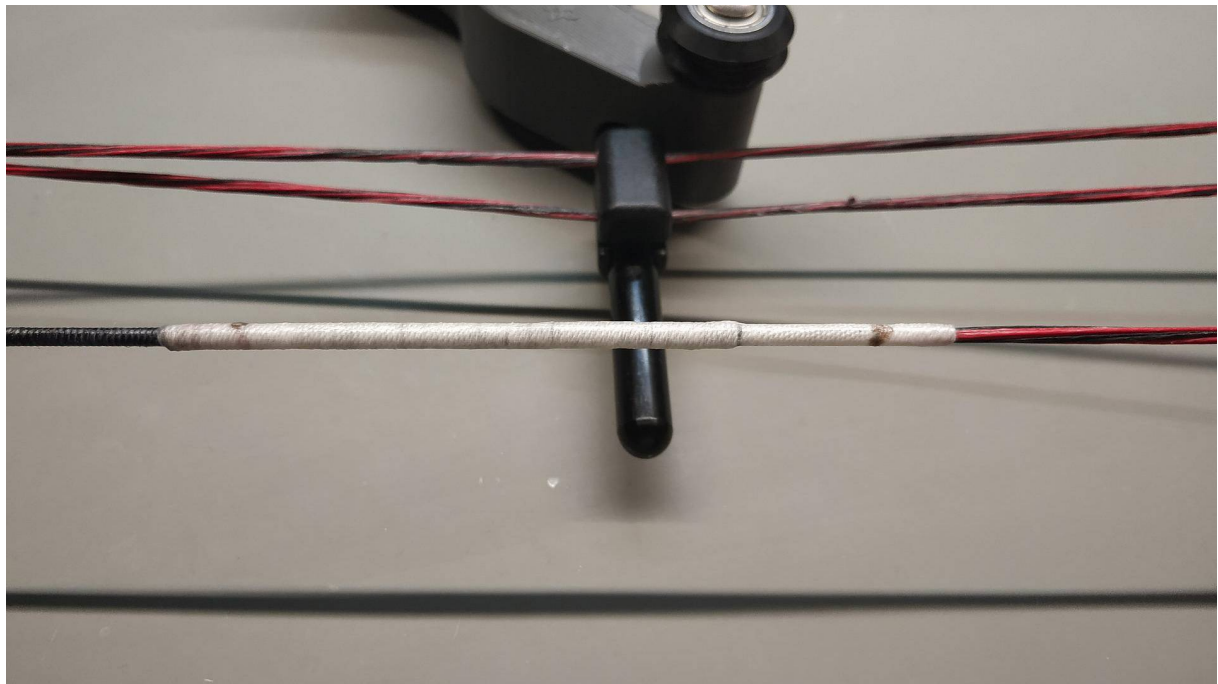

Serving prepared in this way should work for a long time.

### Adjusts the draw length and draw weight of the compound bow

SIL hybrid was designed to the EK Archery Assassin / Exterminator compound bow.

Due to the use of cheap and relatively short 15 inch bolts, the actual range of the compound bow adjustment is limited. The bolts are not long, so the maximum draw length that can be set in the bow is 25 inches (24 inches recommended). When designing, I assumed a minimum draw length of 20 inches, so the draw length of the bow can be set to 20 - 25 inches in 6 steps (positions from "L" to "G"). Together with the distance from the *release* to the rear handle it actually gives a total draw length in the range of 22.5 - 27.5 inches.

String Post Position	Module	Draw Length	Draw Weight (lb)	Limb Bolt Back-off-# of Turns						
				1	2	3	4	5	6	7
Minus-	A	31	70	66	62	58	55	52	49	
0	B	30	64	61	58	55	52	49	46	
0	C	29	60	57	54	51	48	45	42	
0	D	28	56	53	50	47	44	41	38	
0	E	27	54	51	48	45	42	39	36	
0	F	26	52	49	46	43	40	37	34	
0	G	25	50	47	44	41	38	35	32	29
0	H	24	48	45	42	39	36	33	30	27
0	I	23	46	43	40	37	34	31	28	25
0	J	22	44	41	38	35	32	29	26	23
0	K	21	41	38	35	31	29	26	23	21
0	L	20	38	35	32	29	26	24	22	20
0	M	19	36	33	31	28	25	22	18	
Plus+	N	18	34	31	28	26	23	20	15	

- possible draw length and draw weight range

- recommended settings for fast and effective shooting

According to the compound bow manufacturer's table for the draw length range of 20-25 inches, we have a draw weight range of 22-50 lbs. With one additional turn on the limbs (-7 of turns), the actual adjustment range is 20-50 lbs.

In this range of draw weight we can get speed and bolt energy:

- min 20 lbs, 20 inches draw length and -7 turns on bow limbs - about 130 fps / 13 J
- max 50 lbs, 25 inches draw length and 0 turns on bow limbs - about 245 fps / 47 J

To shoot quickly and efficiently, I recommend setting the draw length to 24 inches (position "H") and the draw weight to 27-39 lbs (-7 to -3 turns):

- 27 lbs, 24 inches draw length and -7 turns on bow limbs - about 170 fps / 23 J
- 39 lbs, 24 inches draw length and -3 turns on bow limbs - about 220 fps / 38 J



After setting the draw length on a compound bow, make sure the *draw\_holder* (or *draw\_limiter*) is bolted in the correct position. There are 6 positions available in 25mm increments. This corresponds to 6 possible draw length settings.



The adjusting screws on the new compound bow are very hard to move, and the EK Archery Allen key from set is small, which can damage the screw heads when trying to adjust the draw weight. I suggest you coat the threads of the bolts with PTFE grease and use a good 3/16 inch Allen key. A few turns back and forth and the draw weight adjustment will work lightly.



**If you use a different bow, you need to adjust its settings analogously to those described above.**

### Compatible bolts, tips and broadheads

SIL hybrid is compatible with standard bolts, 15 inches long and 7.5 mm in diameter (carbon bolts for EK Archery Cobra R9 / Cold Steel Cheap Shot 130 crossbows).

Cheaper equivalents of fairly good quality are also available on Aliexpress. They are equipped with a slightly wider orange fletching and orange nocks but also fit into the magazine.

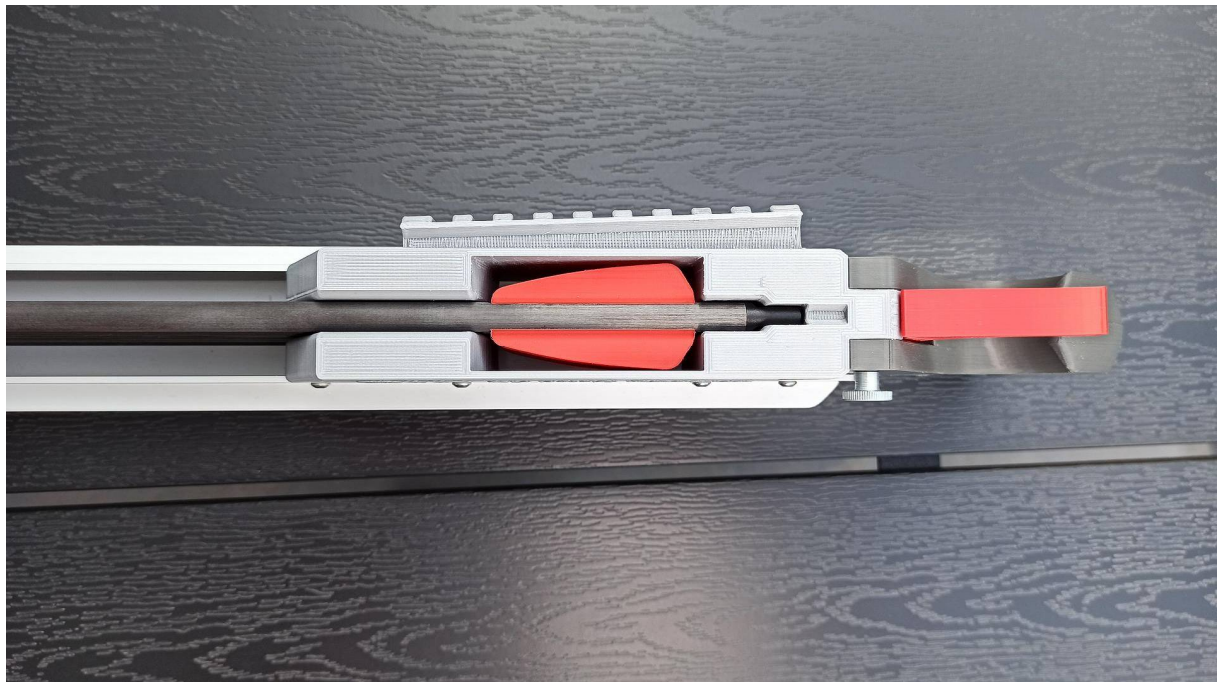
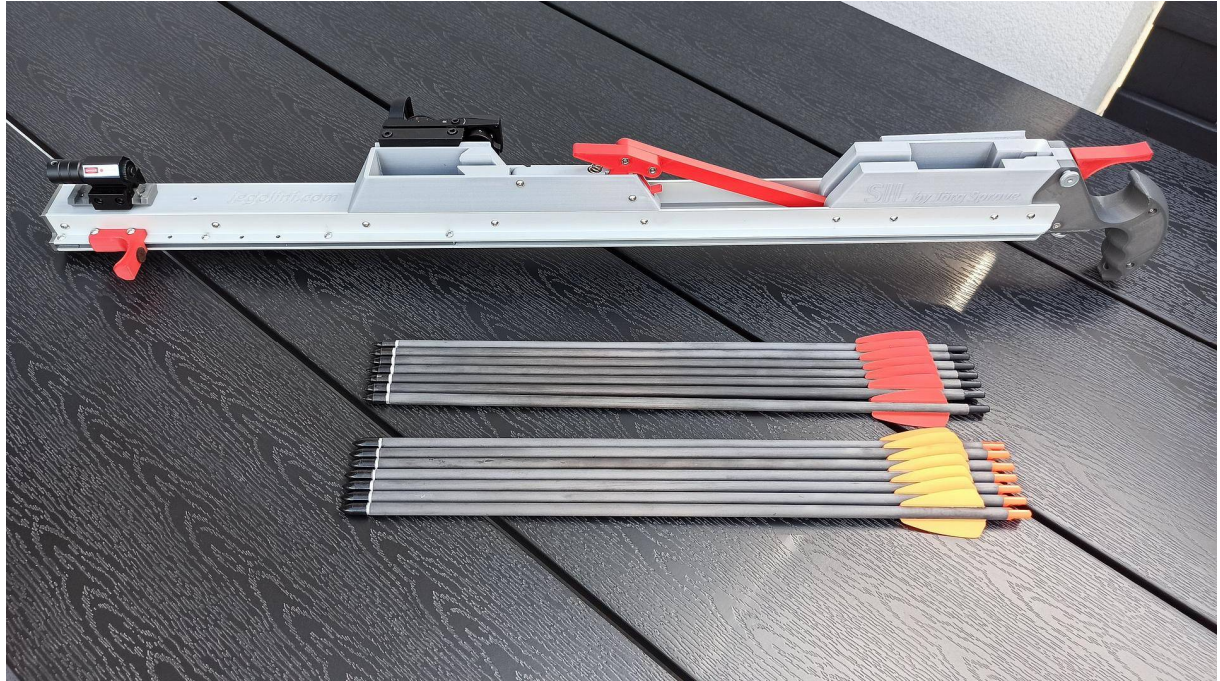

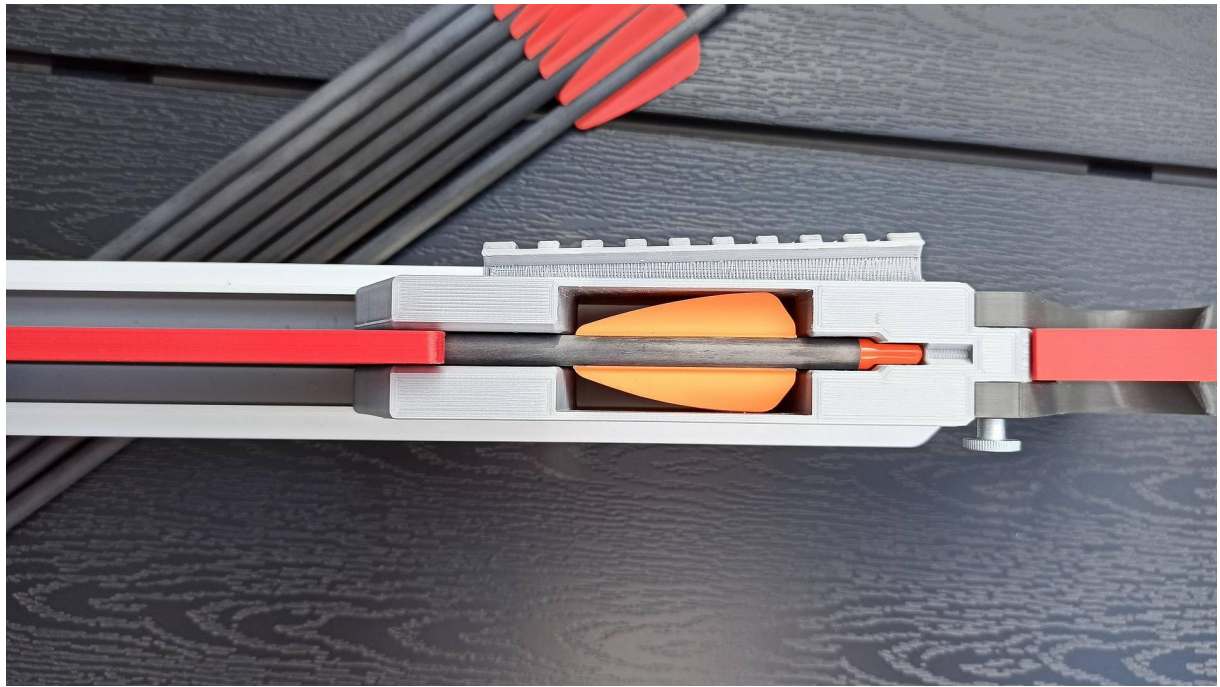

To prevent jamming, before the shooting make sure that only one arrow is in the string slot and arrow guide. The tips of the bolts should be in an array.

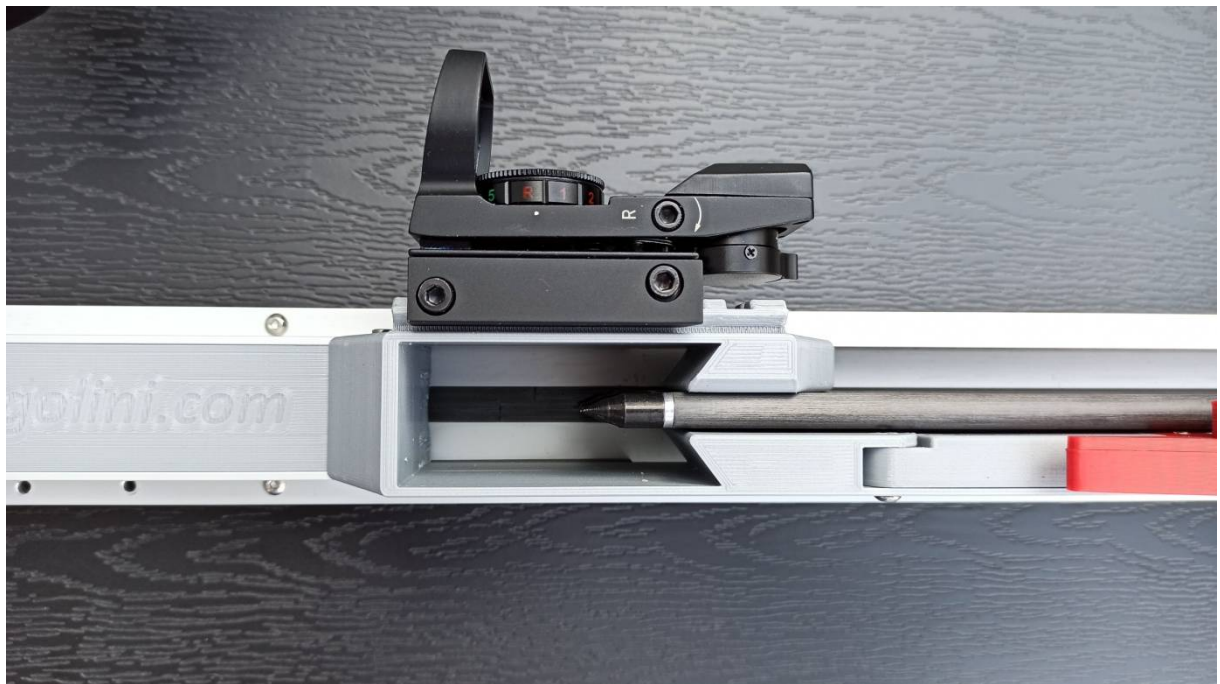

SIL hybrid is also equipped with a chamber that allows the use of various arrowheads with standard thread. Different tips can be used: blunts, target points, field tips, bodkin points and broadheads. The tips must not be thicker than the diameter of the bolt shaft (7.5 mm). Broadheads must be stackable, not wider than 28 mm and no longer than 45 mm. Examples of compatible tips in the pictures below.

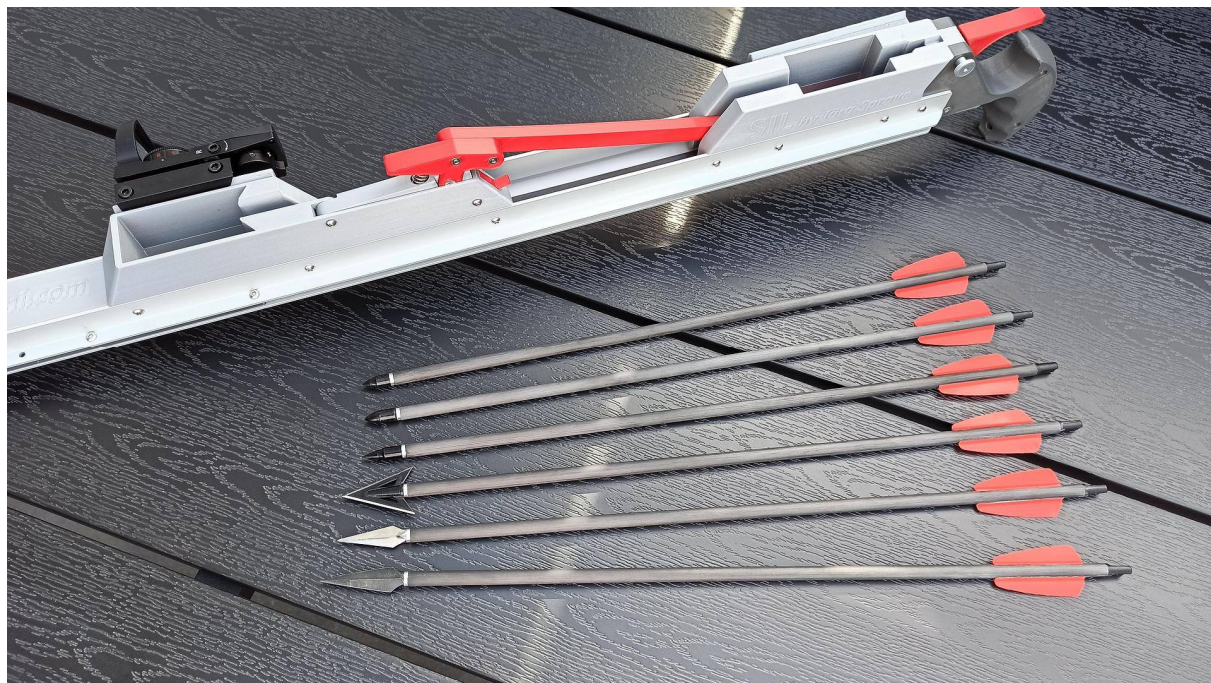



## Summary

I hope you can build your own *SIL hybrid pump-action repeating bow* based on my instructions. It's not particularly complicated, but it does require patience and some manual skills, but you will certainly be fine.

Shooting with the SIL hybrid bow is really a lot of fun.

Now some good advice:

- remember about your safety and the safety of others during DIY works and using the SIL bow
- use only good-quality and undamaged parts and SIL bolts
- regularly check the condition of the serving, bow string and compound bow cables
- before starting the shooting, check the condition of the entire device, in particular the tightening of the screws and the condition of the 3D printed parts
- to prevent jamming and damaging the device, before firing the first shot, make sure that only one arrow is in the string slot and arrow guide

*I would like to thank Jörg Sprave for his inventions, help, good word, inspiration to act and make dreams come true. Without him, this project would certainly not have been possible.*

*Łukasz Janikowski*